

## 03-316 Removal and installation of pistons

### Coordination piston-cylinder

Engine	Piston code number	Group no.	Standard dimension Std	
			Piston dia.	Cylinder dia.
All	10.18	0	90.845 – 90.855	90.898 – 90.908
		1	above 90.855 – 90.865	above 90.908 – 90.918
		2	above 90.865 – 90.875	above 90.918 – 90.928

### Piston standout

Distance between piston crown and cylinder crankcase parting surface	standout max. 0.9 standout min. 0.5
--	--

Test values	When new	Wear limit	
Piston clearance	0.043–0.063	0.12	
Difference in weight of pistons in one engine	5 g	10 g	
Piston pin dia.	27.995–28.000		
Piston pin clearance	in bushing	0.018–0.029	–
	in piston	0.00–0.01	–
Gap clearance of piston rings	groove 1	0.20–0.40	1.5
	groove 2	0.15–0.35	1.0
	groove 3	0.20–0.45	1.0
Side clearance of piston rings	groove 1	0.110–0.142	0.20
	groove 2	0.070–0.112	0.15
	groove 3	0.030–0.062	0.1

### Tightening torque

Connecting rod nuts	initial torque	40–50 Nm
	angle of rotation torque	90–100°

## Special tools

Expanding pliers for piston rings

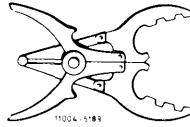

000 589 51 37 00

Clamping strap for piston rings

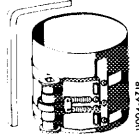

000 589 04 14 00

Angle of rotation tool

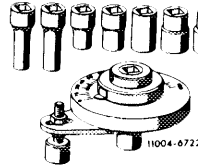

116 589 01 13 00

## Note

The group number 0, 1 or 2, the piston code number, e.g. 10 and the driving direction arrow are punched into piston crown.

The group number is also punched into cylinder crank-case parting surface.

Both group numbers (cylinder bore and piston) must be in agreement.

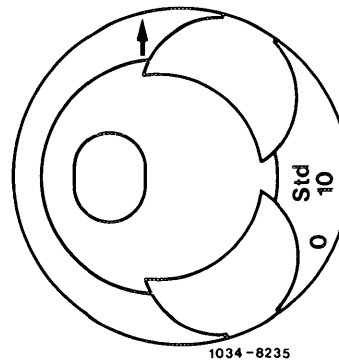

The specified piston clearance will then be maintained.

In the event of repairs, hone cylinder bores to dimensions of available piston plus piston clearance.

The piston shank is graphite-treated.

Due to the higher thermic load, the pistons are cooled by means of an annular duct located in piston crowns (functional description refer to 18-040).

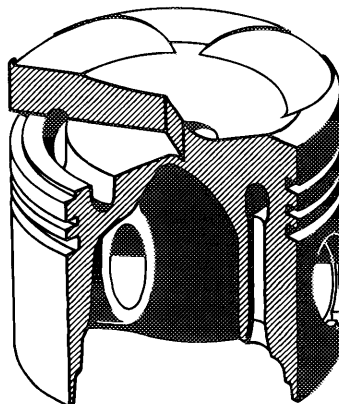

## Removal

---

### Attention!

To avoid damage to oil spray nozzles caused by contact with connecting rod during removal of piston, remove oil spray nozzles (arrow) first (18-040).

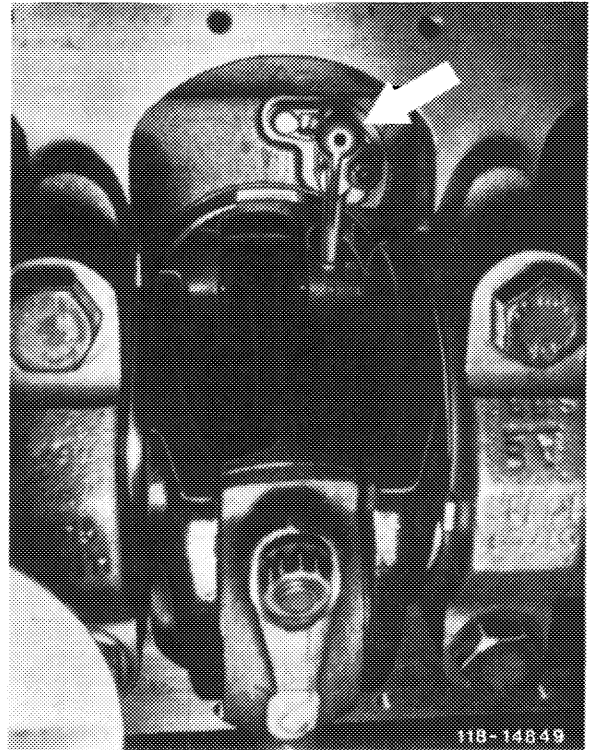

## Removal

---

1 Remove connecting rod with piston in upward direction.

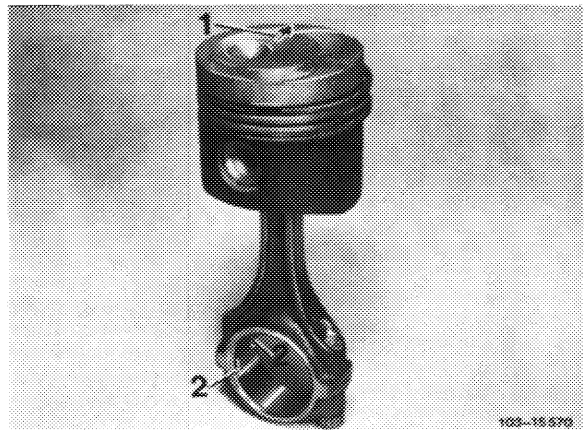

2 Remove piston pin lock and force out piston pin.

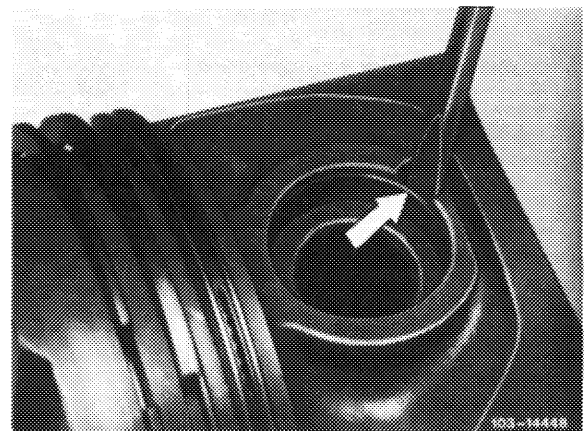

3 Recondition and square connecting rod (03-313).

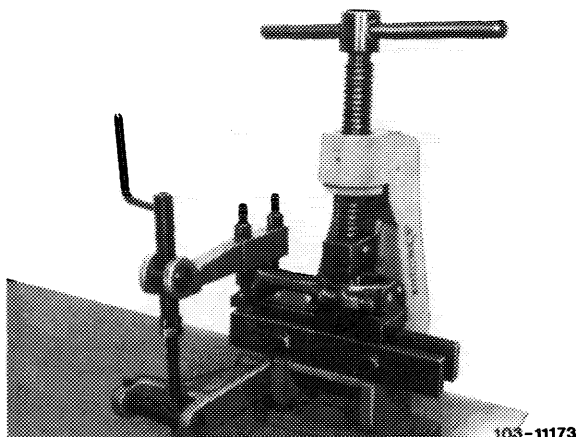

### Installation

4 Place piston on connecting rod in such a manner that the arrow (1) is pointing in driving direction and the lock nuts (2) in connecting rod are pointing to lefthand engine side.

#### Attention!

Do not heat piston.

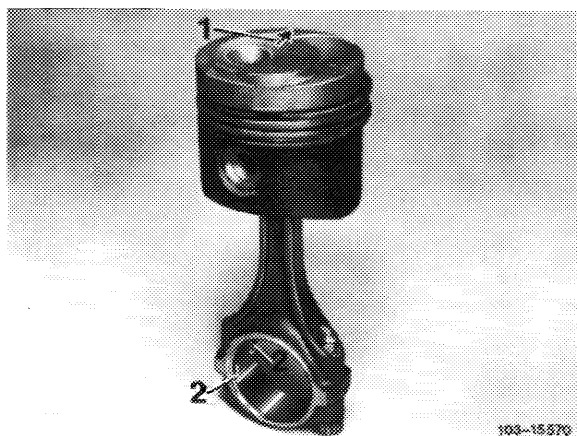

5 Push-in piston pin coated with engine oil **manually**.



6 Place piston pin lock into groove.

Check piston rings for easy operation.

When installing used pistons, check piston rings for gap and side clearance.

7 Lubricate clean cylinder bores, connecting rod bearing journals, connecting rod bearing shells and pistons.

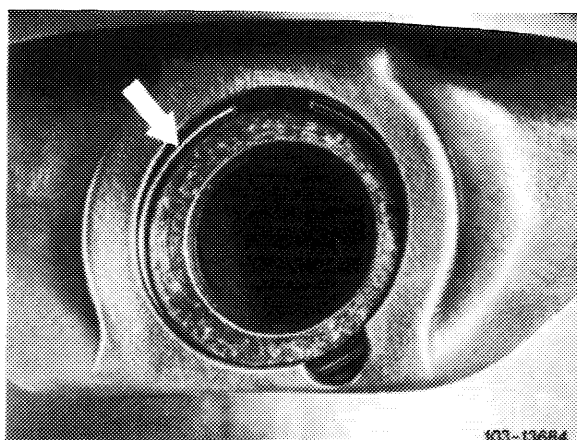

8 Distribute gaps of piston rings uniformly along circumference of piston.

9 Position piston ring clamping strap and insert piston.

The arrow in piston crown should point in driving direction.

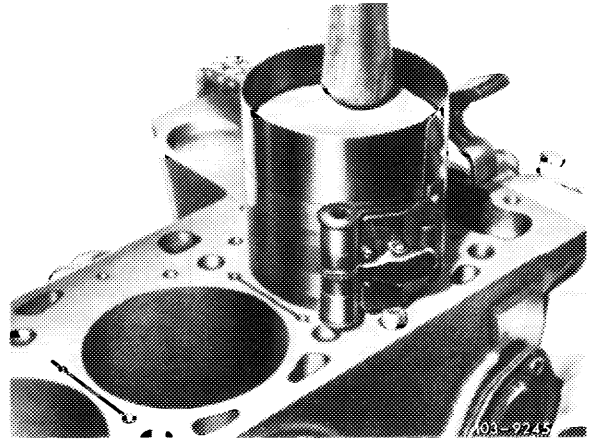

10 Place connecting rod bearing cap with code numbers facing each other on connecting rod, lubricate connecting rod nuts, tighten to 40–50 Nm preload and 90–100° angle of rotation torque.

11 Rotate crankshaft and check clearance between piston pin eye and connecting rod.

12 In TDC position of pistons, measure distance between piston crown and cylinder crankcase parting surface (refer to table).

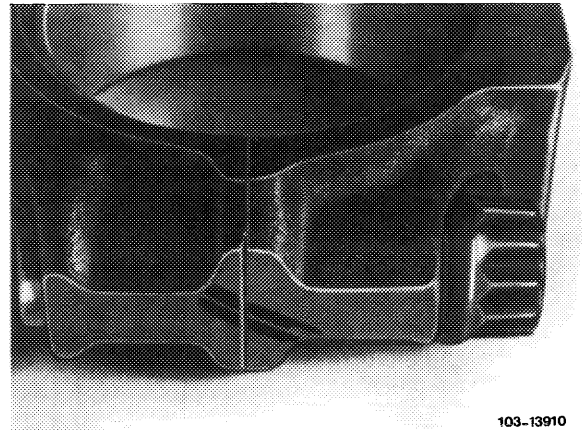

13 Install oil spray nozzles (18–040).

### Piston and connecting rod

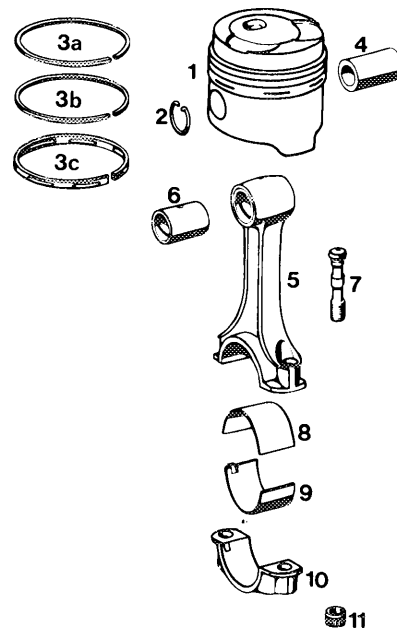

- 1 Piston
- 2 2 piston pin locks
- 3a Rectangular ring 3 mm
- 3b Rectangular ring 2 mm
- 3c Chamfered oil ring with expanding spring
- 4 Piston pin
- 5 Connecting rod
- 6 Connecting rod bushing
- 7 2 connecting rod bolts
- 8 Connecting rod bearing upper and lower half
- 10 Connecting rod bearing cap
- 11 2 connecting rod nuts

1033-7786/1