

07.3–275 Removal and installation of fuel filter

Special tool

Clamp for fuel hose

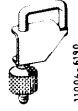

000 589 40 37 00

Note

The fuel filter is additionally provided with an integrated damper for reducing noise. To prevent contact corrosion, the fuel filter carries a plastic sleeve.

When changing fuel filter, be sure that the plastic sleeve is mounted between fuel filter and holder. Sleeve should project on both sides of holder, since direct contact of fuel filter with holder may lead to contact corrosion.

Removal

- 1 Unscrew protective box.
- 2 Pinch off fuel suction hose (1) with clamp.

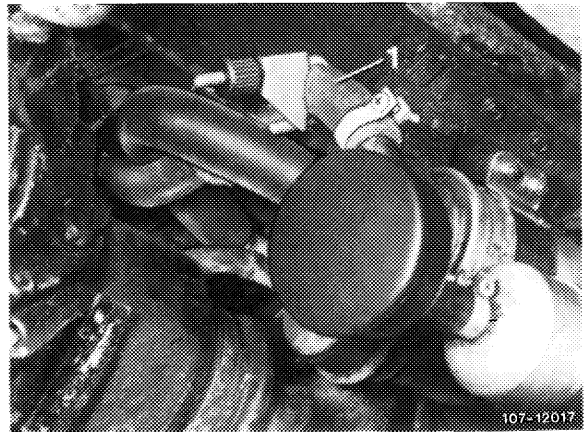

- 3 Unscrew both fuel hoses or fuel line and fuel hose on fuel filter.
- 4 Loosen both fastening screws (arrow) and remove fuel filter.

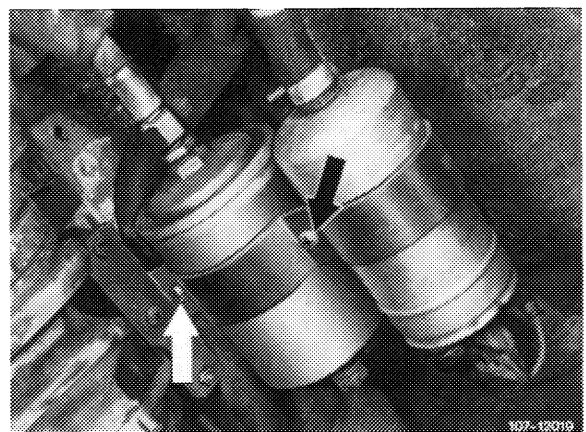

1st version

2nd version

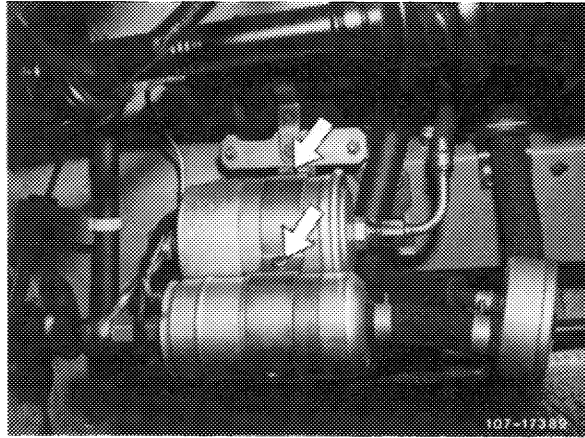

5 For installation proceed vice versa, using new sealing rings.

6 Locate fuel filter with plastic sleeve in holder. Plastic sleeve should project on both sides of holder, since direct contact of fuel filter with holder may result in contact corrosion.

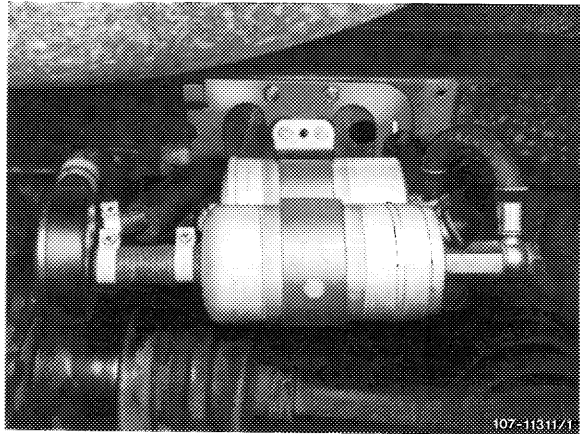

7 Remove clamp on fuel suction hose.

8 Run engine and check for leaks.

9 Mount protective box.

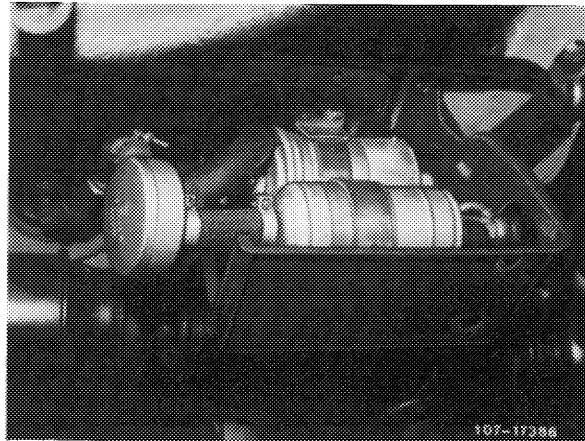

1st version

- 2 Fuel feed line
- 4 Holder
- 5 Vibration damper
- 6 Holder
- 7 Circlip
- 8 Nut
- 9 Hollow screw
- 10 Sealing ring
- 11 Fuel hose
- 12 Fuel hose
- 13 Hose clip
- 14 Fuel storage reservoir
- 15 Holder
- 16 Nut
- 17 Screw
- 18 Protective box
- 19 Fuel hose
- 20 Fuel hose
- 21 Fuel filter
- 22 Fuel pump
- 23 Fuel hose
- 24 Damper

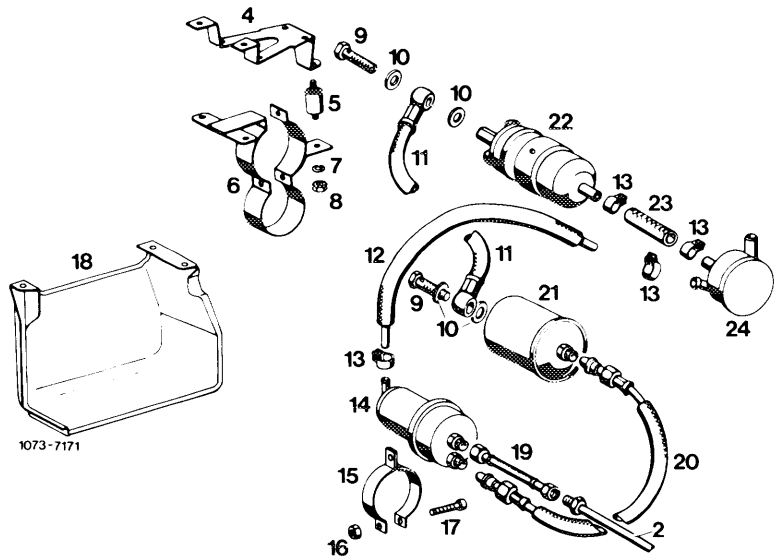

2nd version

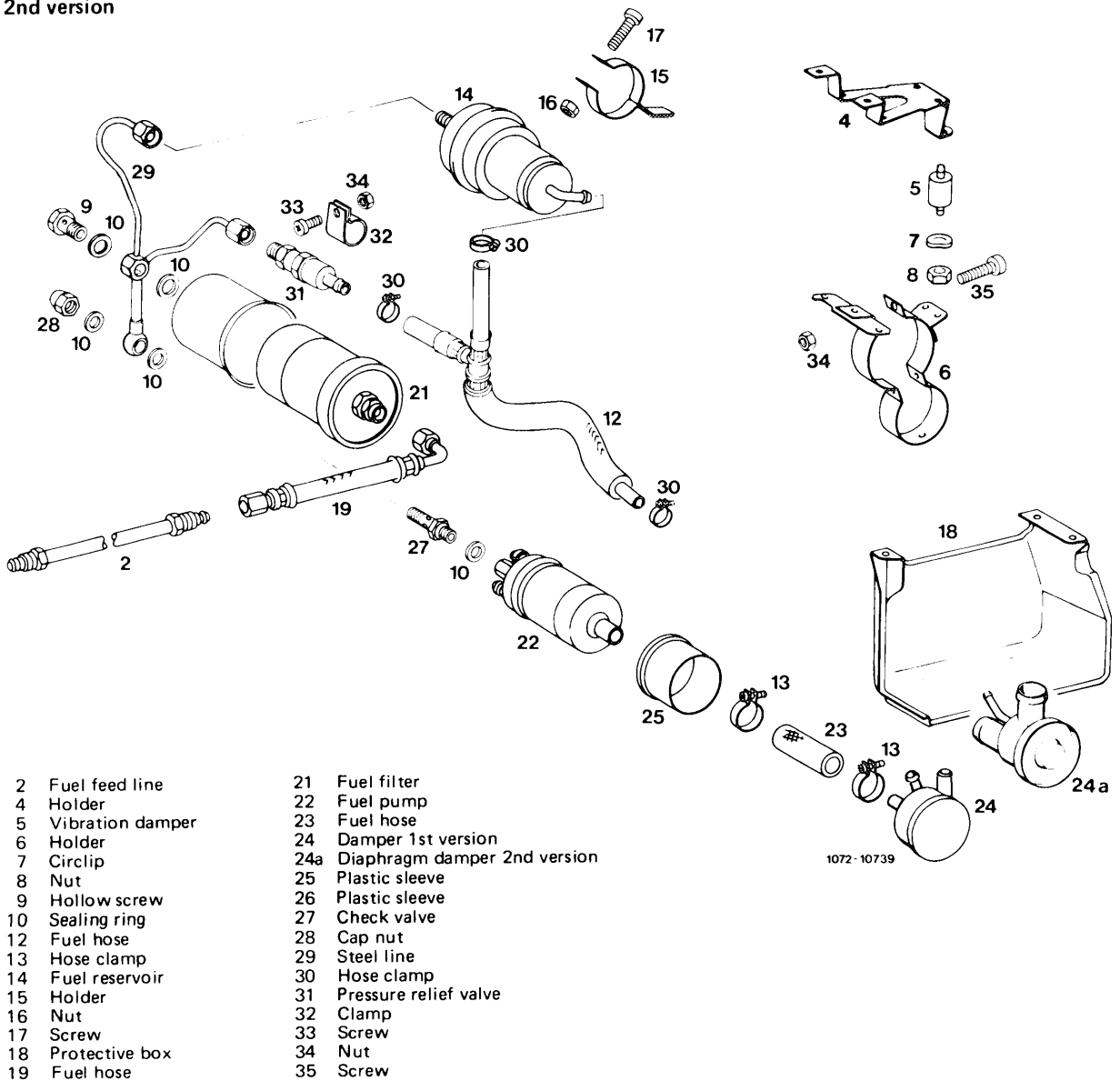

- 2 Fuel feed line
- 4 Holder
- 5 Vibration damper
- 6 Holder
- 7 Circlip
- 8 Nut
- 9 Hollow screw
- 10 Sealing ring
- 12 Fuel hose
- 13 Hose clamp
- 14 Fuel reservoir
- 15 Holder
- 16 Nut
- 17 Screw
- 18 Protective box
- 19 Fuel hose
- 21 Fuel filter
- 22 Fuel pump
- 23 Fuel hose
- 24 Damper 1st version
- 24a Diaphragm damper 2nd version
- 25 Plastic sleeve
- 26 Plastic sleeve
- 27 Check valve
- 28 Cap nut
- 29 Steel line
- 30 Hose clamp
- 31 Pressure relief valve
- 32 Clamp
- 33 Screw
- 34 Nut
- 35 Screw