

07.3–100 Adjustment of idle speed

A. Standard version

Testing and adjusting data

Idle speed	700–750/min
Idle speed emission value	0.5–1.5 % CO

Special tools

Screwdriver 3 mm with tommy handle for regulating idle speed emission value

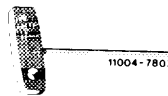

000 589 14 11 00

Oil telethermometer



116 589 27 21 00

Conventional tools

CO-measuring instrument, revolution counter (speedometer)

Digital tester

e.g. Bosch, MOT 001.03

Note

Do not adjust idle speed when engine is too hot, e.g. immediately following a fast ride or after measuring output on output dynamometer.

Adjustment

- 1 Switch off air-conditioner or automatic climate control. Move selector lever into position "P".
- 2 Remove air filter.
- 3 Connect test instruments: Revolution counter, CO-measuring instrument, digital tester, oil telethermometer.
- 4 Run engine to operating temperature (75–85 °C engine oil temperature).

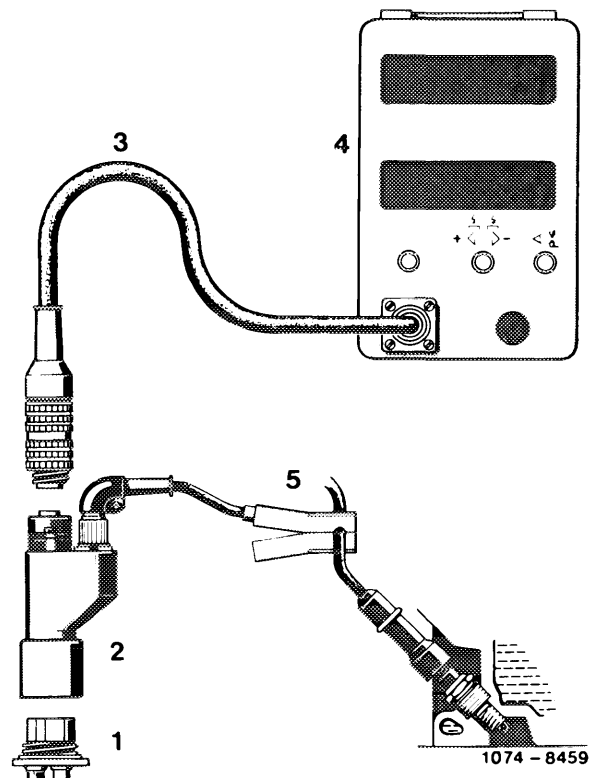

5 Check intake system for leaks. For this purpose, spray all seal points with Iso-Oktan DIN 51756 or benzine.

Attention!

Do not use conventional fuel for spraying (vapors dangerous to health), note inflammability and do not spray on red hot components or parts of ignition system.

6 Check whether bowden wire for tempomat/cruise control rests free of tension against regulating lever (arrow). Set with adjusting nut (1), if required.

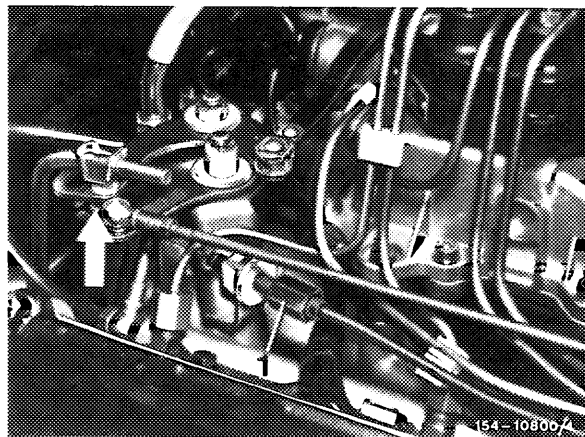

7 Check whether roller (3) in gate lever (4) rests free of tension against end stop. Adjust by means of connecting rod (2), if required.

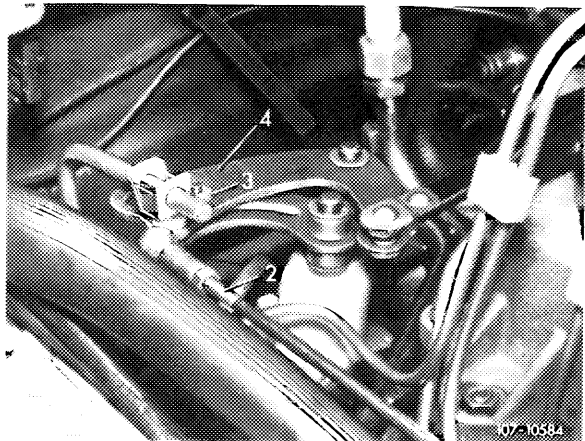

8 Adjust specified speed by means of idle speed air screw (arrow).

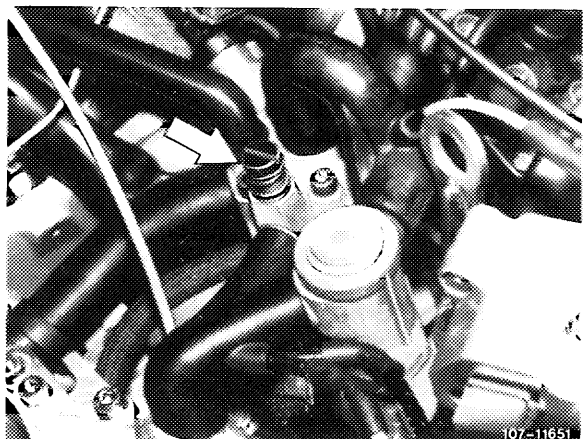

9 Adjust idle speed emission value. For this purpose, unscrew closing plug (arrow).

Attention!

On vehicles manufactured after October 1, 1976, remove safety plug first.

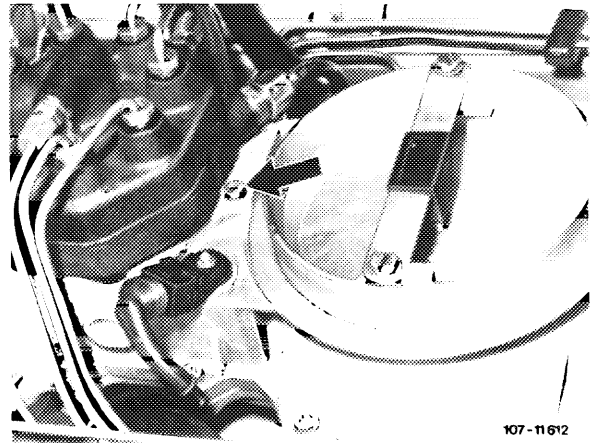

Insert screw driver through bore into socket on idle speed mixture control screw and adjust emission value by turning.

Turning counterclockwise = leaner
Turning clockwise = richer

Hold bore for closing plug closed. Accelerate for a short moment, check idle speed emission value and adjust, if required. Put back closing plug.

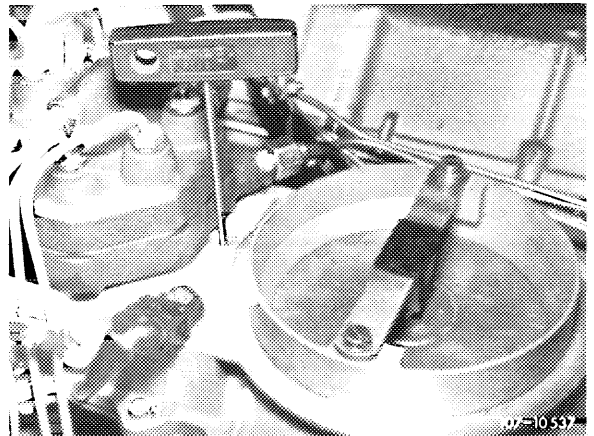

Following adjustment, on vehicles manufactured after October 1, 1976, install a blue safety plug (arrow) MB-part no. 000 997 56 86.

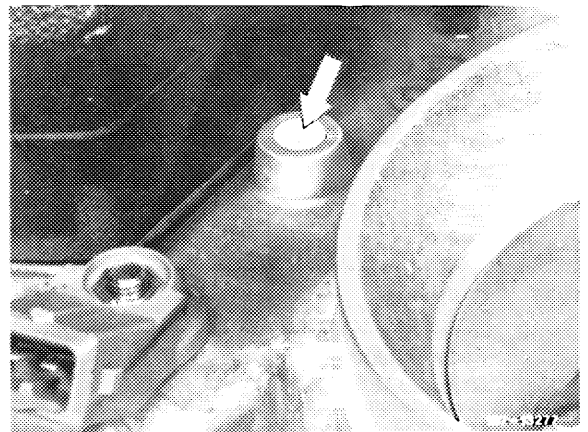

10 Mount air filter. Check idle speed and idle speed emission value once again, and adjust, if required.

11 Place selector lever into driving position, switch on air-conditioner, turn power steering to full lock with engine smoothly running. Adjust speed, if required.

B. National version (AUS) (J) (S) (USA)

Identification: Information plate in respective language on cross member in front of radiator. Adjust engines according to data of respective emission control information plate.

Testing and adjusting data engine 117

Model year	Information plate	Idle speed 1/min	Idle speed emission value % CO	
			without air injection	with air injection

(AUS)

1977	silver	750	0.2–2.0	–
1978–1980			1.0–2.5	–

(J)

1976–1980	in Japanese language	700–800	0.2–1.5	–
-----------	-------------------------	---------	---------	---

(S)

1976	blue	700–800	0.2–1.5	–
1977/78		750	0.2–2.0	–
1979/80			1.0–2.5	–

(USA)

1976	Federal	black	700–800	0.2–1.5	–
	California	green			
1977	Federal	black	750	–	0.2–2.0
	California	yellow		0.2–2.0	–
	Federal high altitudes	red		–	0.2–1.2
1978/ 79	Federal	black	750	–	0.5–2.0
	California	yellow		0.5–2.0	–
1980 ¹⁾	Federal and California	black	650 ± 50	–	0.5–1.5

¹⁾ Tourist version model 107 only. These vehicles are provided without catalysts and without O₂ probe ex factory.

Special tools

Screw driver with tommy handle for adjusting
idle speed emission value

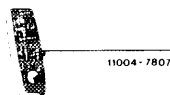

000 589 14 11 00

Oil telethermometer



116 589 27 21 00

Conventional tools

CO-measuring instrument, revolution counter (speedometer)

Digital tester

e.g. Bosch, MOT 001.03



Note

Do not adjust idle speed when engine is too hot, e. g. immediately after a fast drive or after measuring output on output dynamometer.

Adjustment

- 1 Switch off air-conditioner or automatic climate control. Move selector lever into position "P".
- 2 Remove air cleaner.
- 3 Connect test instruments: Revolution counter CO-measuring instrument, digital tester, oil telethermometer.

Connecting CO-measuring instrument

For this purpose, on   starting 1977, pull off connecting hose (arrow) at measuring point (exhaust backpressure line).

Connect CO-measuring instrument and exhaust backpressure line by means of a hose.

USA tourist vehicles outside the USA have no catalyst installed, the emission value can therefore be measured at exhaust end pipe.

- 4 Run engine to operating temperature (75–85 °C engine oil temperature).

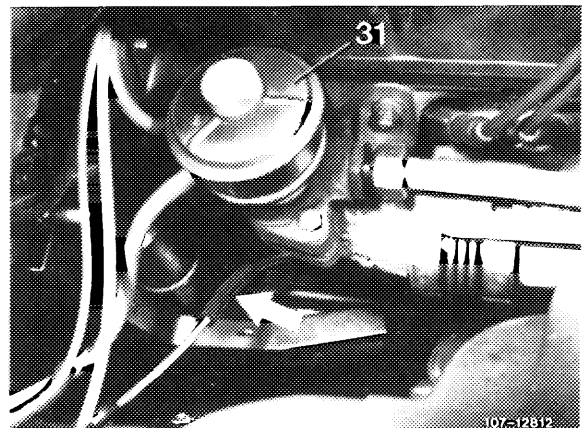
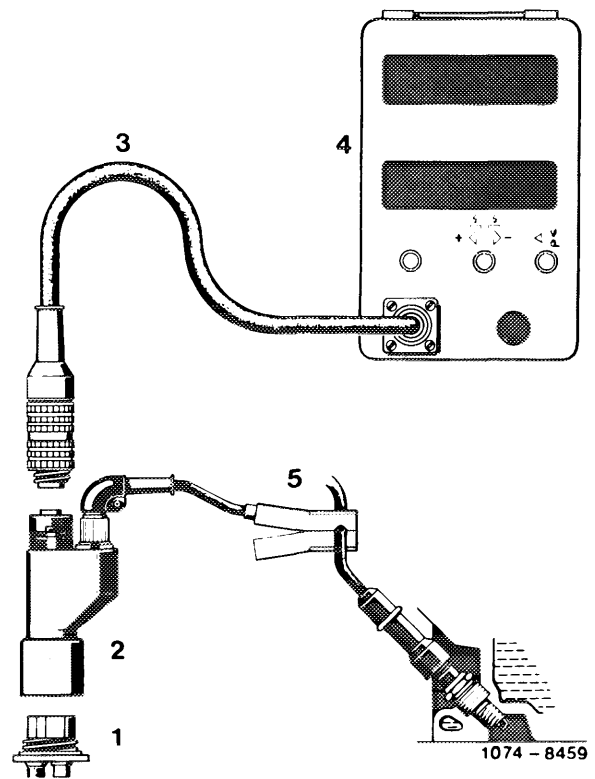

5 Check intake system for leaks. For this purpose, spray all sealed points with Iso-Okтан DIN 51756 or benzine.

Attention!

For spraying, do not use conventional fuel (unhealthy vapors). Pay attention to inflammability and do not spray on red hot components or parts of ignition system.

6 Check whether bowden wire for tempomat/cruise control rests free of tension against regulating lever (arrow). Adjust with adjusting screw (1), if required.

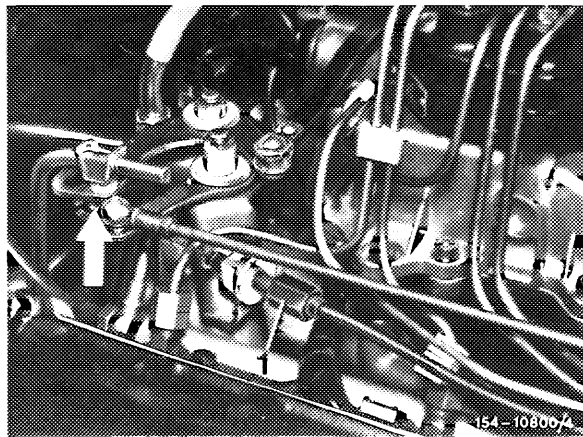

7 Check whether roller (3) in gate lever (4) rests free of tension against end stop. Adjust with connecting rod (2), if required.

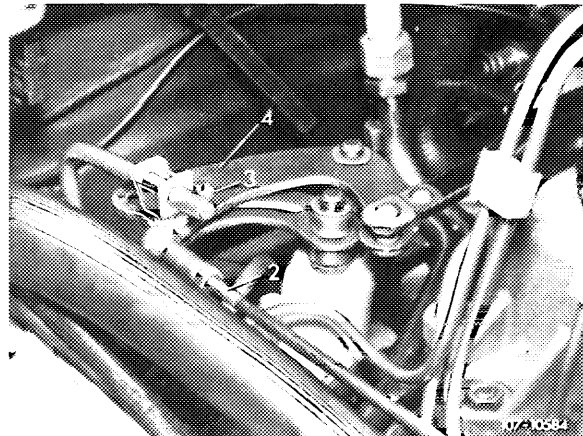

8 Set to specified speed by means of idle speed adjusting screw (arrow).

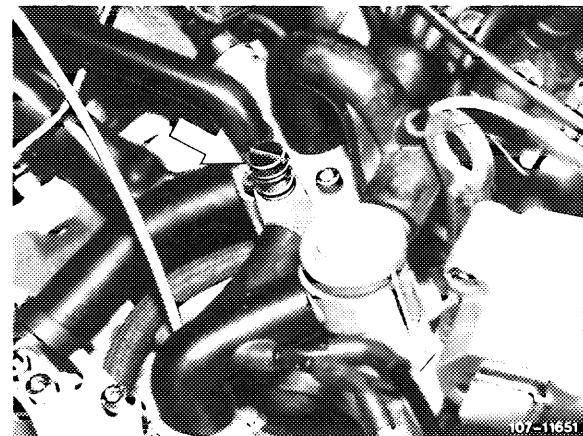

9 Check idle speed emission value.

(AUS) 1977, (J) starting 1976, (S) 1976/77,
(USA) starting 1976

Check idle speed emission value **without air injection**. For this purpose, pull blue/violet vacuum line (arrow) from blue thermovalve (61) and close connection on thermovalve. Thus the air injection is switched off.

(USA) Federal and Federal high altitudes, check idle speed emission value **with** air injection (self-aspirating).

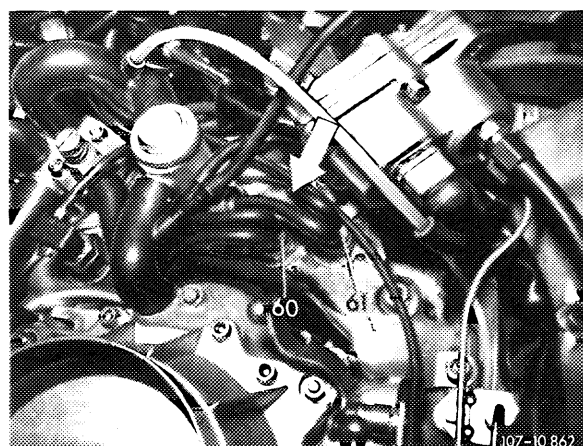

(AUS) starting 1978, (S) starting 1978

Check idle speed emission value **without** air injection. For this purpose, pull vacuum hose (arrow) from retarder valve (77) and close hose. This will shut off the air injection.

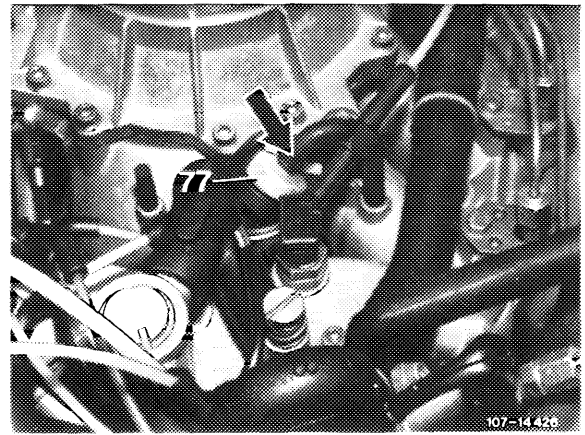

10 **Adjust idle speed emission value.** For this purpose, unscrew closing plug (arrow).

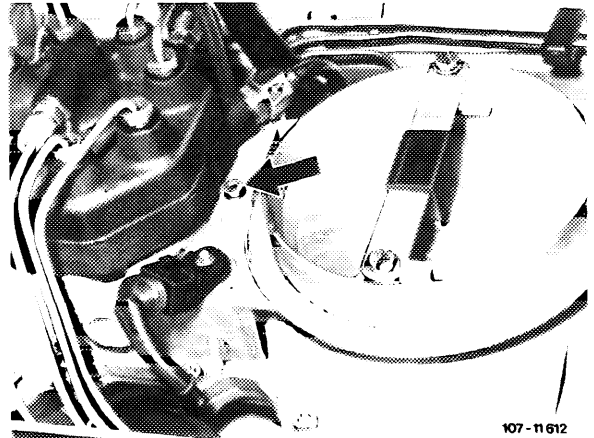

Insert allen wrench through bore into socket of idle speed mixture regulating screw and set emission value by turning screw.

Turning counterclockwise = leaner

Turning clockwise = richer

Close bore for closing plug. Accelerate for a short moment and check idle speed emission value once again or adjust, if required. Put back closing plug.

Plug back vacuum lines with (USA) version on thermo-valve, with (AUS) version at time-delay valve.

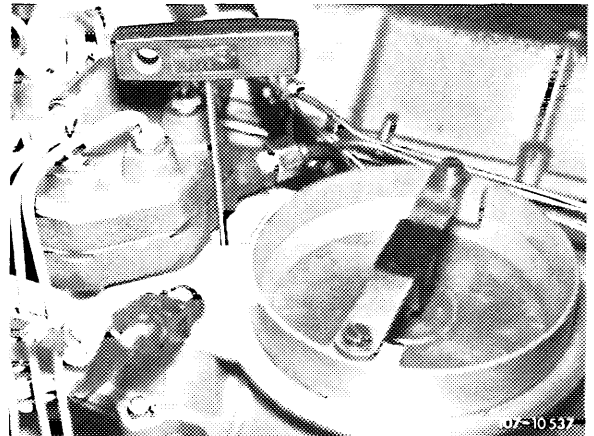

Check idle speed emission value once again (air injection in operation). The idle speed emission value should be **below** previously set value.

11 Mount air cleaner. Check idle speed and idle speed emission value once again and adjust, if required.

12 Place selector lever into driving position, switch on air-conditioner, turn power steering to full lock, engine should run smoothly. Adjust speed, if required.