

05–215 Checking and adjusting of camshaft timing

Timing at 2 mm valve lift

Engine	Camshaft code number left/right	Intake valve		Exhaust valve	
		opens after TDC ¹⁾	closes after BDC	opens before BDC	closes before TDC
116.980					
116.981					
116.982	30/31 ⁴⁾				
116.983	42/43 ⁴⁾	4° (2°)	14°	30°	16°
116.990 ²⁾	46/47 ⁴⁾				
116.991 ²⁾	52/53 ⁵⁾				
116.992 ²⁾					
116.993 ²⁾					
116.984 ³⁾					
116.985 ³⁾	58/59 ⁶⁾	4° (2°)	14°	26.5°	11.5°
117.981 (USA)	46/47 ⁴⁾	4° (2°)	14°	30°	16°
117.984 (USA)	52/53 ⁵⁾				
117.982					
117.983	54/55 ⁷⁾	5° (3°)	21°	25°	5°
117.992 ²⁾	56/57 ⁵⁾ 9)				
117.993 ²⁾					
117.982					
117.983					
117.992 ²⁾	00/01 ⁶⁾ 9)	6.5° (4.5°)	18.5°	23°	8°
117.993 ²⁾					
117.985 ³⁾					
117.986 ³⁾	00/01 ⁶⁾	6.5° (4.5°)	18.5°	23°	8°
117.985 (USA)					
117.986 (USA)	06/07 ⁶⁾	22° (20°)	6°	2° ¹⁰⁾	14°

1) With new timing chains and after driving 20 000 km, change timing of **righthand** camshaft by 2° in direction of advance. Refer to data in brackets.

2) Low compression.

3) Same engine designation for low compression.

4) Replaced by **52/53**.

5) Use with mechanical valve clearance adjustment only.

6) Use with hydraulic valve clearance adjustment only.

7) Replaced by **56/57**.

8) 117.982/992 up to engine end no. 035995 and starting engine end no. 036326 with mechanical valve clearance compensating elements.
117.983/993 up to engine end no. 039155 and starting engine end no. 039612 with mechanical valve clearance compensating elements.



9) 117.982/992 starting engine end no. 035996 to 036325 with hydraulic valve clearance compensating elements.

117.983/993 starting engine end no. 039156 to 039611 with hydraulic valve clearance compensating elements.

10) Opens after BDC.

Tightening torques		Nm
Bolts for cylinder head cover		3
Screw M 14 x 1.5 x 40 for camshaft sprocket		100
Cylinder head bolts with engine cold	step 1	30
	step 2	60
Camshaft bearing bolts on cylinder head		50
Hydraulic valve clearance compensating element in cylinder head		60

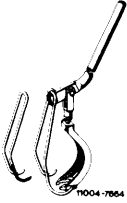
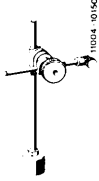
Special tools

Valve spring depressor		123 589 03 61 00
Dial gauge holder		363 589 02 21 00
Valve adjusting wrench 17 mm		116 589 02 01 00

Conventional tool

Dial gauge A 1 DIN 878	e.g. Mahr, D-7300 Esslingen order No. 810
------------------------	--

Note

During assembly jobs, alignment of the markings on camshaft at ignition TDC position of 1st cylinder will be sufficient.

Check "intake valve opens" on 1st and 6th cylinder at 2 mm valve lift.

Checkup

1 Check camshaft code number at rear end of camshafts.

2 On engines with hydraulic valve clearance compensating elements remove rocker arms and valve clearance compensating elements on intake valve of 1st and 6th cylinder. Install valve adjusting screw, part No. 116 050 11 20, on intake valve of 1st and 6th cylinder.

Install rocker arms.

Attention!

Rocker arms and valve clearance compensating elements should always be installed in the same place.

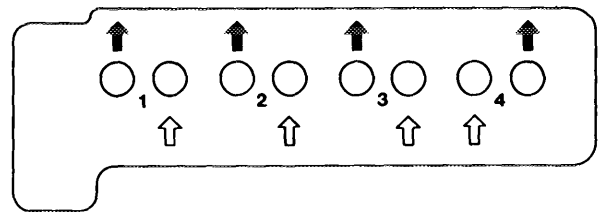

⚡ 1 5 4 8 6 3 7 2

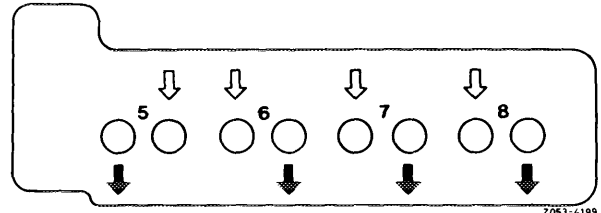

2053-4199

3 Rotate crankshaft (socket 27 mm) until cam tip on intake valve of 1st cylinder is pointing in upward direction.

Rotate crankshaft in engine direction of rotation only.

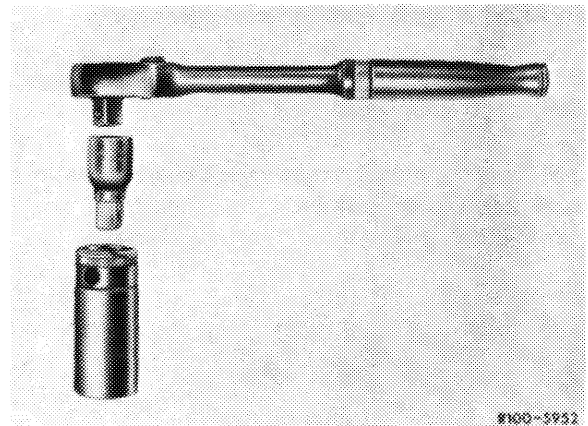

8160-5922

4 Turn valve adjusting screw until rocker arm rests free of play against camshaft base circle.

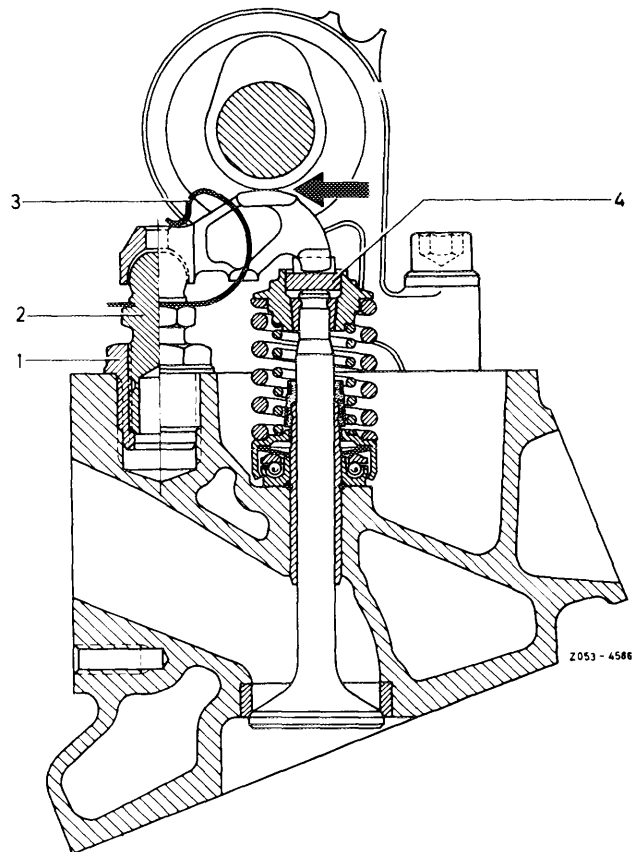

5 Attach dial gauge holder to cylinder head.

6 Clamp dial gauge with extension pin in dial gauge holder at 3 mm preload.

The feeler pin should rest on valve spring retainer in accurately vertical position.

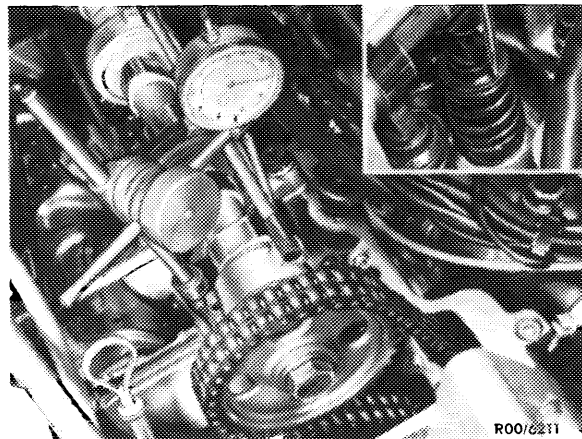

7 Set large needle to 0.

8 Rotate crankshaft in direction of engine rotation until the needles of the dial gauge are moving back by 2 mm to 1 mm preload. The valve lift will then amount to 2 mm.

9 In this engine position, the value on vibration damper should be in accord with value "intake valve opens" on table.

10 Complete test procedure on intake valve of 6th cylinder and repeat item 4 to 9 for this purpose.

Adjustment

If the timing requires corrections, an offset Woodruff key or in the event of excessive elongation, a new timing chain must be installed.

Woodruff keys are available with the following offset:

Offset mm	Part No.	for a correction of approx.
0.7	621 991 04 67	4° KW
0.9	621 991 02 67	6 1/2° KW
1.1	621 991 01 67	8° KW
1.3	621 991 00 67	10° KW

An offset by one tooth on camshaft sprocket results in approx. 18° on crankshaft.

An offset of Woodruff key to the right (in driving direction) results in an earlier (advanced) begin of opening, and an offset to the left in a later (retarded) begin of opening.

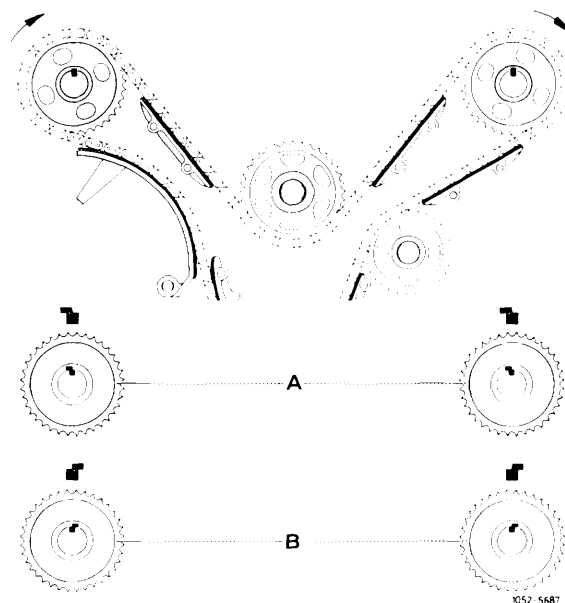

Installation position A results in an earlier (advanced) begin of opening
Installation position B results in a later (retarded) begin of opening

11 Mark camshaft sprockets and timing chain in relation to each other (arrow).

12 Remove respective camshaft sprocket.

13 Place cleaning rag under camshaft and remove Woodruff key.

14 Insert selected Woodruff key.

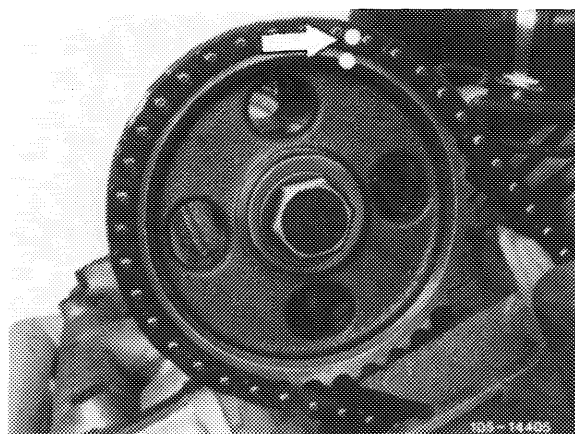

15 Mount camshaft sprocket while paying attention to color code.

The wide collar on camshaft sprocket should face camshaft (arrow).

Do not tighten screw.

16 Repeat item 4 to 9.

17 Tighten screw to 100 Nm.

18 Adjust valve clearance (05—210) or check and correct basic position of hydraulic valve clearance compensating elements (05—213).

19 Complete engine assembly.

