

Pressure reservoir for front axle and central reservoir¹⁾

Color code	red dot	
Gas filling pressure	when new	75 ± 2 bar gauge pressure (atü)
	minimum value	60 bar gauge pressure (atü)
	Permissible differential pressure between left-hand and right-hand pressure reservoir	8 bar gauge pressure (atü)

¹⁾ The pressure reservoirs for the front axle are similar to the central reservoir.

Pressure reservoir for rear axle

Color code	blue dot	
Gas filling pressure	when new	60 ± 2 bar gauge pressure (atü)
	minimum value	45 bar gauge pressure (atü)
	Permissible differential pressure between left-hand and right-hand pressure reservoir	8 bar gauge pressure (atü)

Tightening torque	Nm	(kpm)
Line connections	11	(1.1)

Special tools

Box wrench insert open, 11 mm, 1/4" square, complete with change-over ratchet and 2 extensions for pressure oil lines



116 589 00 17 00

Pressure tester for level control and hydro-pneumatic suspension

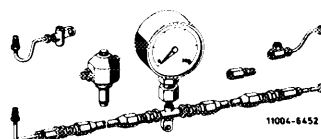

116 589 23 21 00

Funnel with filter



111 589 04 63 00

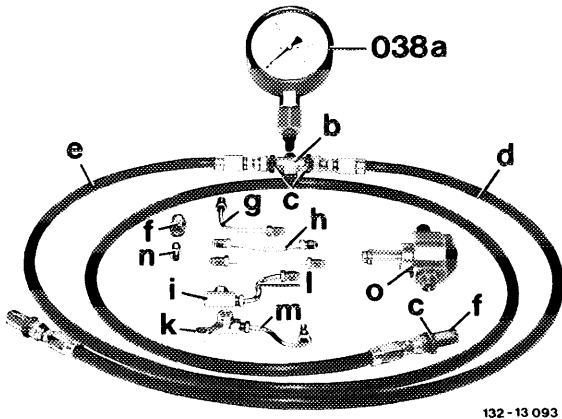

132-13 093

- 038a/039¹ Pressure gauge 0–250/0–160 bar gauge pressure (atü) with adaptor, coupling nut and sealing ring
- 038b Distributor
- 038c Connection
- 038d Test pressure hose, 1000 mm long
- 038e Test pressure hose, 2000 mm long
- 038f Coupling
- 038g Test pressure line
- 038h Test pressure line
- 038i Distributor
- 038k Distributor
- 038l Test pressure line
- 038m Test pressure line
- 038n Bleed valve
- 038o Distributing valve for pressure oil pump

Note

For checking, use pressure tester (38) with a pressure gauge 0–160 or 0–250 bar gauge pressure (atü).

While checking, do not move lever of level controller from central position by more than 30°. Any turning of lever and thereby of control disc beyond the permissible dimension may result in damage to valve balls and to a subsequent internal leakage of regulator.

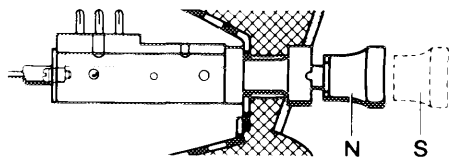

- Move cable control for adjusting switch of valve unit into position N = „Normal level“ and fill central reservoir by running engine (normal filling time of empty central reservoir approx. 30 s at 2000/min of engine).

N = „Normal level“
(switch pushed down or control disc on stop front)

S = „Detent“
(switch engaged in center position or control disc pulled into 1st detent)

- Jack up vehicle at front and rear.

Note: Because of automotive legislation the position „higher level“ – contained in the system – is inoperable for USA vehicles.

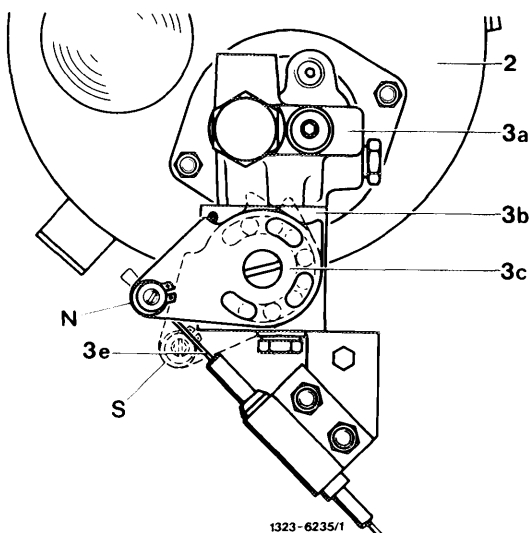

1323-6235/1

- 2 Oil supply tank
- 3a Pressure regulator
- 3b Adjusting switch
- 3c Control disc
- 3e Cable control for adjusting switch

Pressure reservoir for front axle

- Remove battery and battery frame, connect battery cable of vehicle to removed battery by means of emergency starting cable.

- Disconnect connecting rod on level controller for front axle.

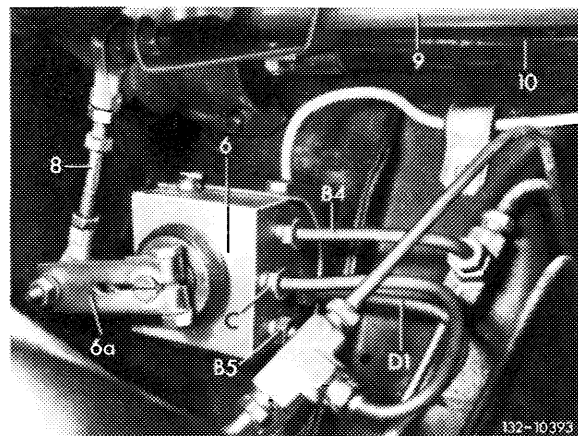

- 6 Level controller for front axle
- 6a Lever for level controller
- 8 Connecting rod
- B4 Pressure line adjusting switch – level controller
- B5 Pressure line level controller – pressure reservoir
- C Control pressure line for „Higher level“ adjusting switch – level controller
- D1 Return line level controller – pressure regulator

- For checking pressure reservoir, unscrew lefthand pressure line (B5) on pressure reservoir and close with coupling (038f) and bleed valve (038n).
- Connect test pressure hose (038e) to pressure reservoir at left.

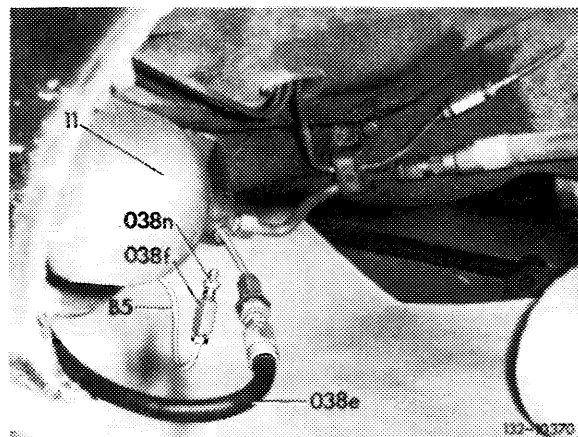

- 11 Pressure reservoir left for front axle
- B5 Pressure line level controller – pressure reservoir
- 038e Test pressure hose, 2000 mm long, with test pressure line (038h)
- 038f Coupling
- 038n Bleed valve

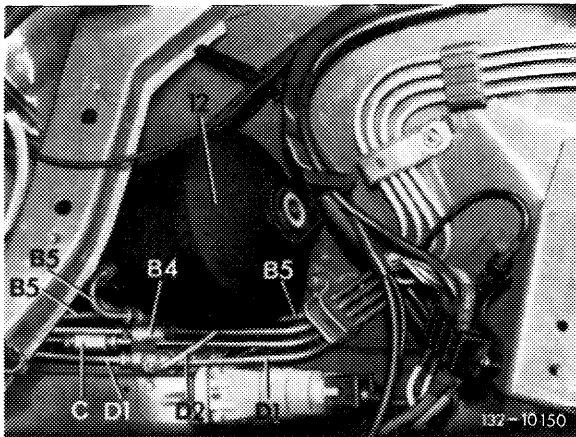

- 12 Pressure reservoir right for front axle
- B4 Pressure line adjusting switch – level controller
- B5 Pressure line level controller – pressure reservoir
- C Control pressure line adjusting switch – level controller
- D1 Return line level controller – pressure regulator
- D2 Return line for leak oil of tube shocks

- Disconnect pressure line (B5) on distributor and on pressure reservoir.
- Connect test pressure hose (038d) with pressure test line (038h) to distributor instead of pressure line (B5).

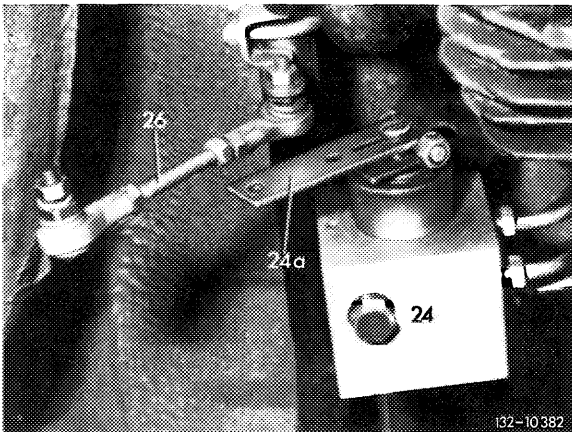

Level controller in position „evacuate“

- 24 Level controller for rear axle
- 24a Lever for level controller
- 26 Connecting rod

- Set lever for front axle level controller to „evacuate“.

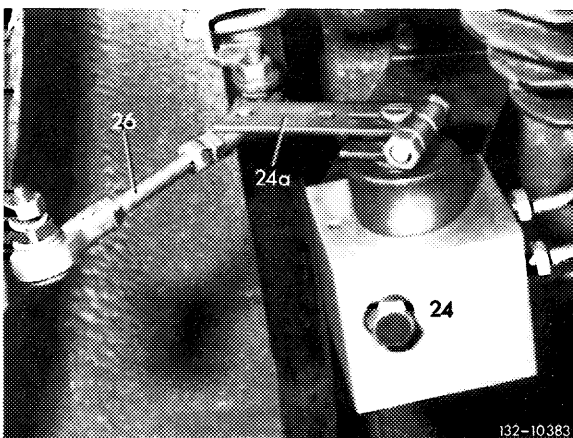

Level controller in position „filling“

- 24 Level controller for rear axle
- 24a Lever for level controller
- 26 Connecting rod

- Run engine at idle, set lever of level controller for front axle to „filling“, while observing needle of pressure gauge.
- The gas filling pressure of the reservoir is indicated, when the needle of the pressure gauge spontaneously indicates pressure. This sudden increase is effected by the oil pressure, when the latter exceeds the gas pressure. Set lever of level controller to „evacuate“. Stop engine.

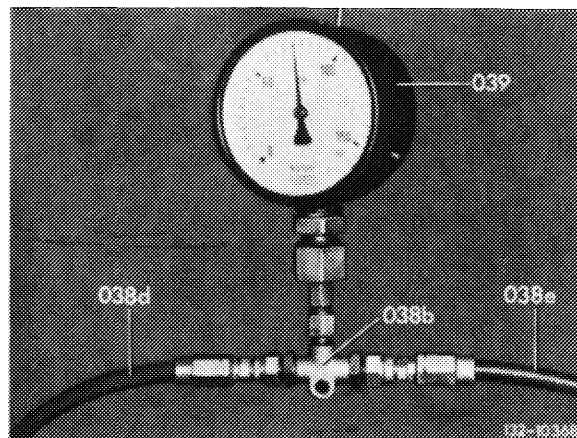

039/038a Pressure gauge 0–160/0–250 bar gauge pressure (atü)
038b Distributor
038d Test pressure hose, 1000 mm long
038e Test pressure hose, 2000 mm long

Disconnect pressure test hose (038e) with pressure line (038h) on pressure reservoir left.

- The pressure line (B5) to pressure reservoir left remains closed.

- To check pressure reservoir right, connect test pressure hose to pressure reservoir.

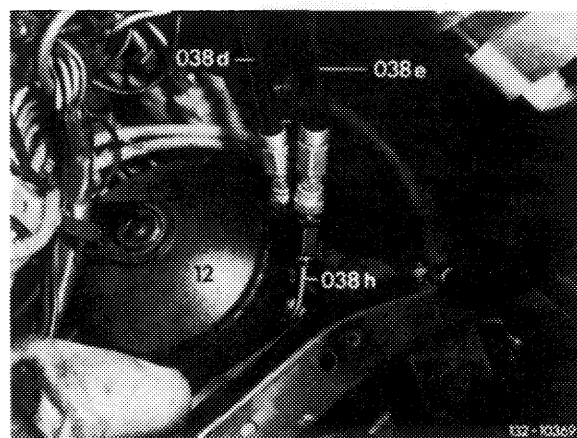

12 Pressure reservoir right for front axle
038d Test pressure hose, 1000 mm long
038e Test pressure hose, 2000 mm long
038h Test pressure line

- Check right-hand pressure reservoir similar to left-hand reservoir.

- Disconnect pressure tester, connect pressure lines on pressure reservoirs and on distributor to wheel house right. Install battery and battery frame.

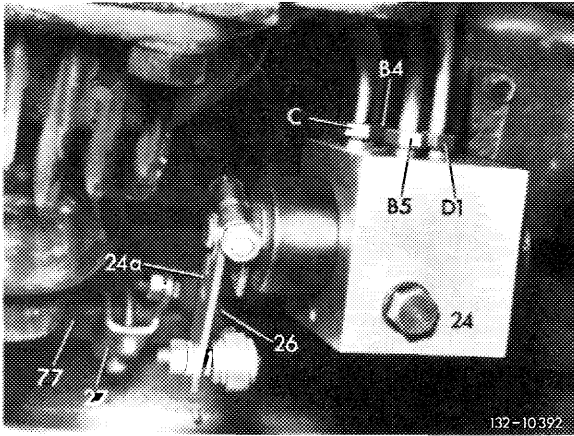

- 24 Level controller for rear axle
- 24a Lever for level controller
- 26 Connecting rod
- B4 Pressure line adjusting switch – level controller
- B5 Pressure line level controller – Pressure reservoir
- C Control pressure line for „Higher level”
adjusting switch – level controller
- D1 Return line level controller – pressure regulator

Pressure reservoir for rear axle

- Disconnect connecting rod for level controller on rear axle.

- Disconnect pressure lines (B5) on both pressure reservoirs and on level controller.

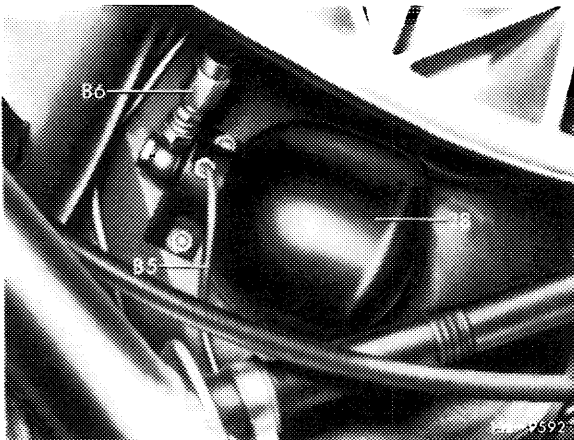

- 28 Pressure reservoir left for rear axle
- B5 Pressure line level controller – pressure reservoir
- B6 Pressure line pressure reservoir – tube shock

- Connect pressure gauge (039/038a) 0–160/0–250 bar gauge pressure (atü) with test pressure hose (038d) and test pressure line (038g) on connection for pressure line (B5) on level controller and test pressure hose (038e) with test pressure line (038h) on left-hand pressure reservoir.

- Set lever of level controller for rear axle to „evacuate“.

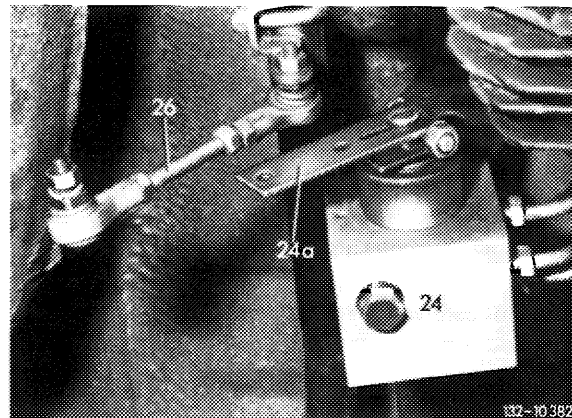

Level controller in position „evacuate“

- 24 Level controller for rear axle
- 24a Lever for level controller
- 26 Connecting rod

- Run engine at idle speed. Set lever of level controller for rear axle to „filling“, while observing needle of pressure gauge.
- The gas filling pressure of the pressure reservoir is indicated, when the needle of the pressure gauge spontaneously indicates pressure. This sudden increase is effected by the oil pressure, when the latter exceeds the gas pressure. Set lever of level controller to „evacuate“. Stop engine.

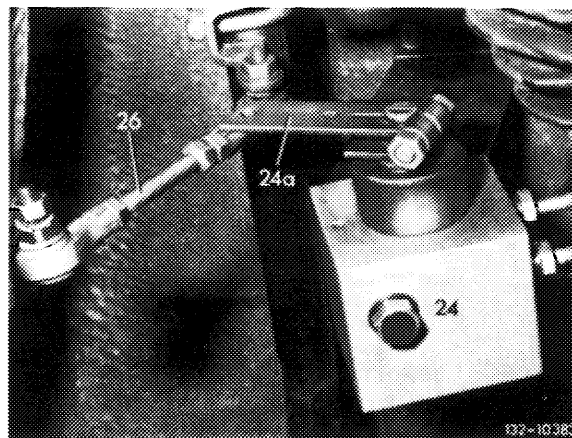

Level controller in position „filling“

- 24 Level controller for rear axle
- 24a Lever for level controller
- 26 Connecting rod

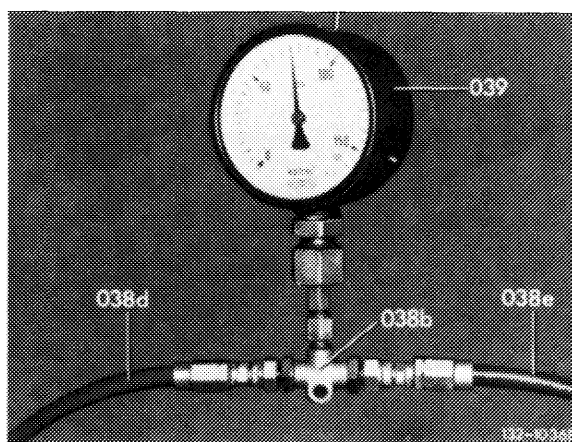

- 039/038a Pressure gauge 0–160/0–250 bar gauge pressure (atü)
- 038b Distributor
- 038d Test pressure hose, 1000 mm long
- 038e Test pressure hose, 2000 mm long

- Loosen test pressure hose with test pressure line on left-hand pressure reservoir and connect to right-hand reservoir.
- Complete checkup of right-hand pressure reservoir similar to left-hand reservoir.
- Disconnect pressure tester, connect pressure lines to pressure reservoirs and to level controller.
- Mount connecting rods of level controllers for front and rear axle.
- Lower vehicle.

Attention! Low ground clearance!

- Run engine to fill suspension system (filling time of empty suspension system approx. 60 seconds at 2000/min. of engine).

Central reservoir

- Move cable control for adjusting switch of valve unit into position S = „detent position“.

N = „normal level“
(switch pushed down or control disc at stop front)

S = „detent position“
(switch engaged in center position or control disc pulled into first detent)

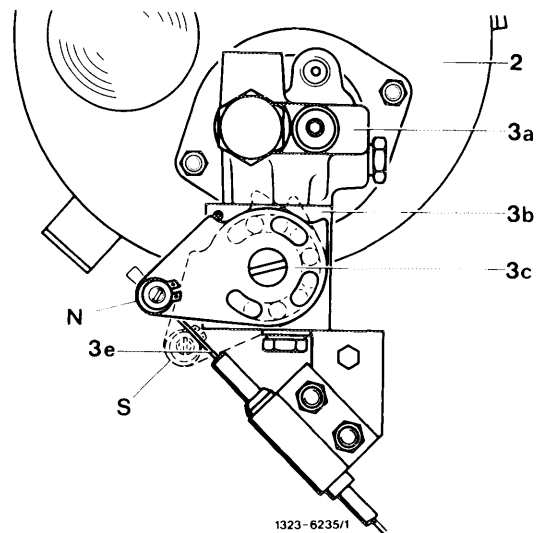
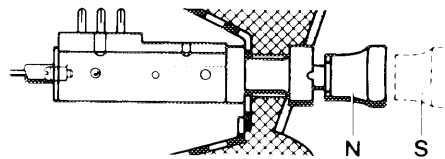

- 2 Oil supply tank
- 3a Pressure regulator
- 3b Adjusting switch
- 3c Control disc
- 3e Cable control for adjusting switch

- Disconnect pressure line (B4) adjusting switch – level controller on adjusting switch.

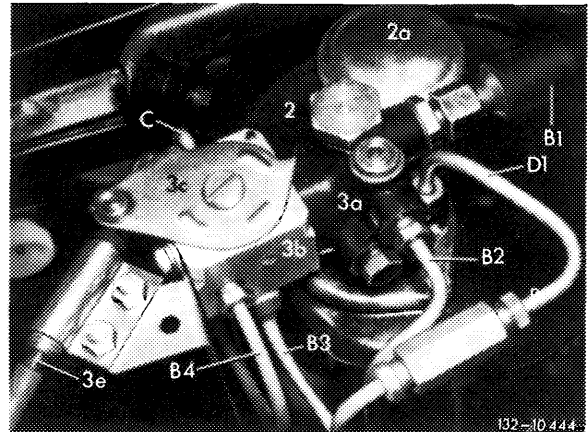

- 2 Oil supply tank
- 2a Closing cover with oil dipstick
- 3a Pressure regulator
- 3b Adjusting switch
- 3c Control disc
- 3e Cable control for adjusting switch of valve unit
- B1 Pressure line pressure oil pump-pressure regulator
- B2 Pressure line pressure regulator-central reservoir
- B3 Pressure line central reservoir-adjusting switch of valve unit
- B4 Pressure line adjusting switch-level controller
- C Control pressure line „higher level” adjusting switch – level controller
- D1 Return line level controller – pressure regulator

- Connect pressure gauge 0–160/0–250 bar gauge pressure (atü) (039/038a) with distributor (038i) and test pressure line (038i) to adjusting switch and to pressure line (B4).

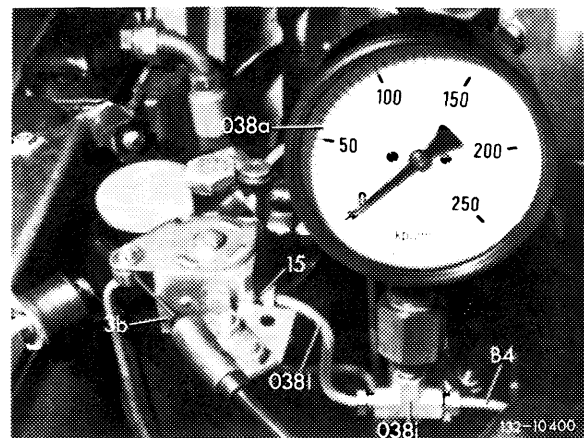

- 3b Adjusting switch
- B4 Pressure line
- 15 Connection for pressure line B 4
- 038a/039 Pressure gauge
- 038i Distributor
- 038i Test pressure line

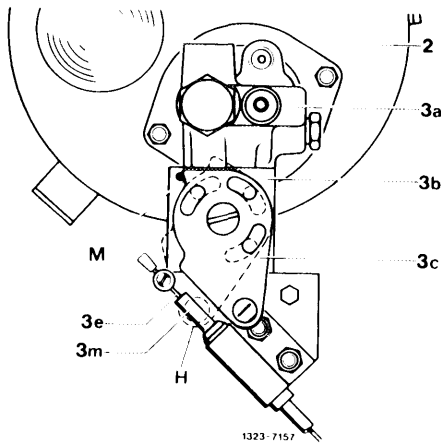

Position M = „assembly“ of adjusting switch

- 2 Oil supply tank
- 3a Pressure regulator
- 3b Adjusting switch
- 3c Control disc
- 3e Cable control for adjusting switch of valve unit

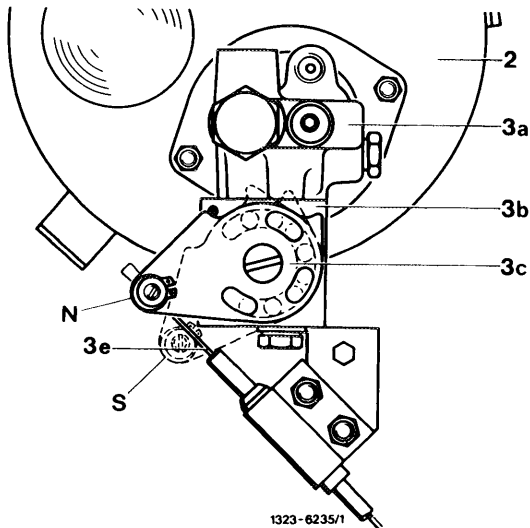
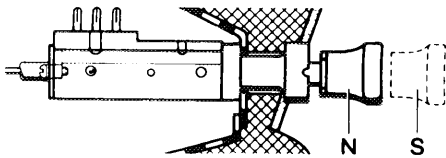

- 2 Oil supply tank
- 3a Pressure regulator
- 3b Adjusting switch
- 3c Control disc
- 3e Cable control for adjusting switch

- Disconnect cable control for adjusting switch on control disc. For this purpose, remove locking ring.
 - Push control disc of adjusting switch to the rear against stop in position M = „assembly“. Keep engine running.
 - Move control disc of adjusting switch into position N = „normal level“, while observing pressure gauge.
- N = „normal level“
(switch pushed in or control disc against stop front)
- S = „detent position“
(switch engaged in center position or control disc pulled into 1st detent)

The gas filling pressure of the central reservoir is indicated when the needle of the pressure gauge spontaneously indicates pressure. This sudden increase is effected by the oil pressure when the latter exceeds the gas pressure. Stop engine.

- Move control disc of adjusting switch into position M – „assembly“.
- Disconnect pressure tester, attach pressure line to adjusting switch.

- Attach cable control on control disc of adjusting switch and move into position N = „normal level“.
- To fill central reservoir, run engine (normal filling time of empty central reservoir up to cutout pressure approx. 30 seconds at 2000/min of engine).
- Correct oil level in oil supply tank.

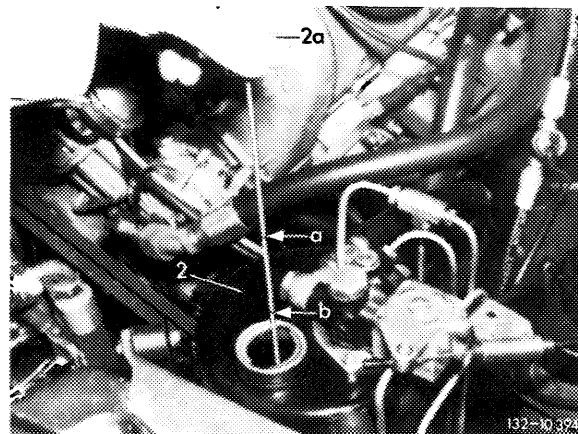

- 2 Oil supply tank
- 2a Closing cover with oil dipstick
- a Max. mark
- b Min. mark