





05–270 Replacement of valve stem seals

Valve clearance	with engine cold (approx. 20 °C)	with engine warm (60 °C ± 15 °C)
Intake	0.10 ¹⁾	0.15 ¹⁾
Exhaust	0.35	0.40

¹⁾ 0.05 mm higher during lasting outside temperatures below –20 °C.

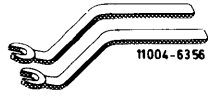
Tightening torque	Nm
Nuts for cylinder head cover	15

Special tools

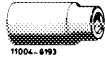
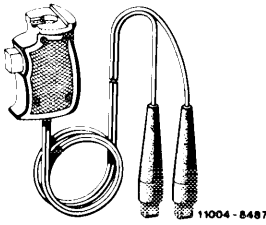
Valve adjusting wrench 14 mm (2 each)		615 589 00 01 00
Holding wrench for valve spring retainer		615 589 00 03 00
Slip gage holder, red		617 589 00 40 00
Slip gage blades	0.10 mm thick	617 589 00 23 00
	0.15 mm thick	617 589 01 23 00
	0.20 mm thick	117 589 00 23 00
	0.35 mm thick	617 589 03 23 00
	0.40 mm thick	617 589 04 23 00
Assembly mandrel for valve stem seals Intake and exhaust		617 589 00 43 00
Socket 27 mm, 1/2" square, for rotating engine		001 589 65 09 00
Contact handle for rotating engine (component of compression pressure recorder 001 589 46 21 00)		001 589 46 21 08

Conventional tool

Cylinder leak tester

e.g. made by Bosch, EFAW 210 A
made by SUN, CLT 228

Note

Valve stem seals of intake and exhaust valves are of different design and should not be mixed up. They are differently colored to show difference.

Intake valve stem seal — **black**

Exhaust valve stem seal — **green**

In addition to oil wiper lip (A), the valve stem seals also have a gas sealing lip (B).

A Oil wiper lip
B Gas sealing lip

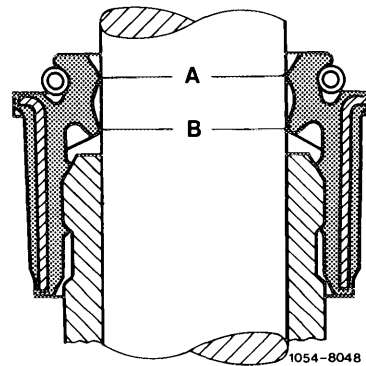

Renewing

- 1 Remove rocker arms with rocker arm brackets (05-235).
- 2 Remove valve springs (05-250).
- 3 Force off valve stem seals with a screwdriver or pull off with pliers.

Attention!

Do not damage valve stem and valve guide.

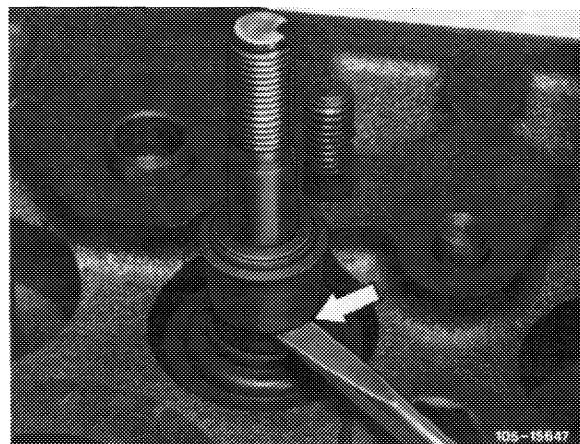

4 Lubricate new valve stem seals and mount by means of assembly mandrel.

For this purpose, be sure to place an assembly sleeve on valve stem.

5 Install valve springs (05-250).

6 Install rocker arms with rocker arm bearing brackets (05-235).

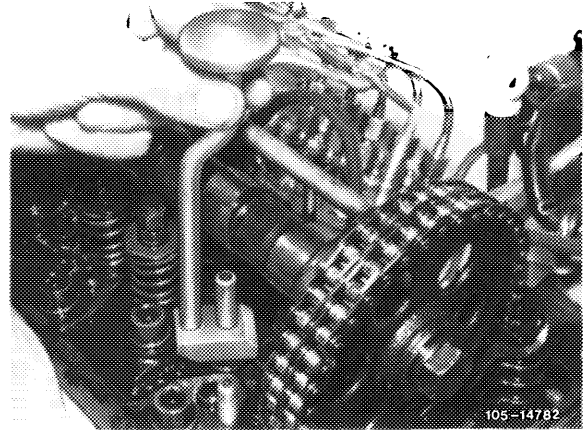

7 Adjust valve clearance (05-210).

