

## 07.4-040 Testing electronically controlled gasoline injection

### A. With Bosch tester EFAW 228

#### Conventional tool

Bosch tester EFAW 228

made by Bosch GmbH  
D-7000 Stuttgart 30

#### Connection diagram for control unit

The following wiring diagram shows the individual components of the electronically controlled gasoline injection system and its connection to the control unit.

#### Engine 116

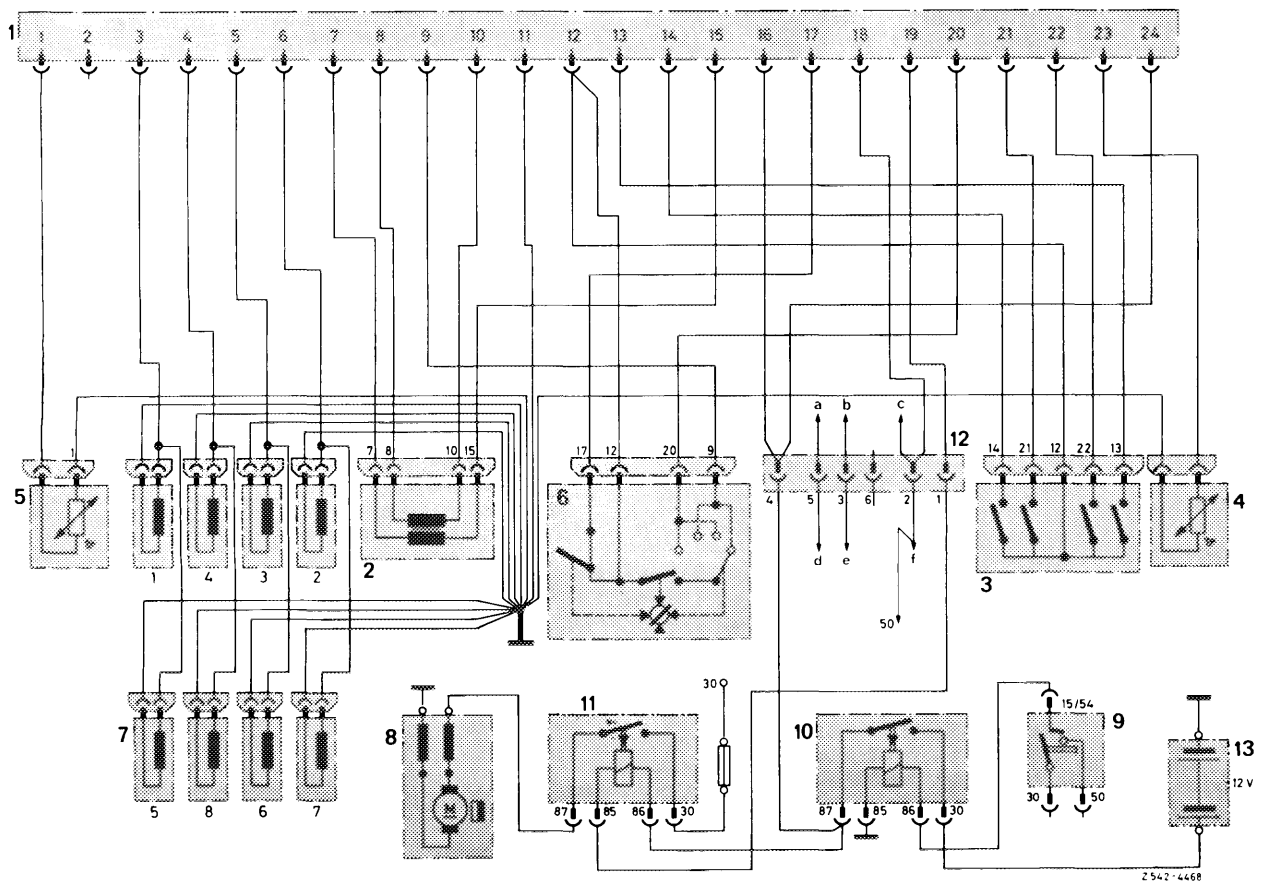

- 1 Multi-point connector control unit
- 2 Pressure sensor
- 3 Release contacts in ignition distributor
- 4 Temperature sensor cooling water
- 5 Temperature sensor air
- 6 Throttle valve switch
- Terminal 9 transition enrichment
- Terminal 20 transition enrichment
- Terminal 12 ground
- Terminal 17 idle speed contact

- 7 Injection valves
- 8 Fuel pump
- 9 Ignition starting switch
- 10 Main relay electronic system
- 11 Pump relay

- 12 Plug connection to vehicle harness
- a To cold starting valve
- b To thermo-time switch terminal W
- c To thermo-time switch terminal G
- d To cold starting relay terminal 87
- e To cold starting relay terminal 85
- f To cold starting relay terminal 86
- 13 Vehicle battery

# Engine 117

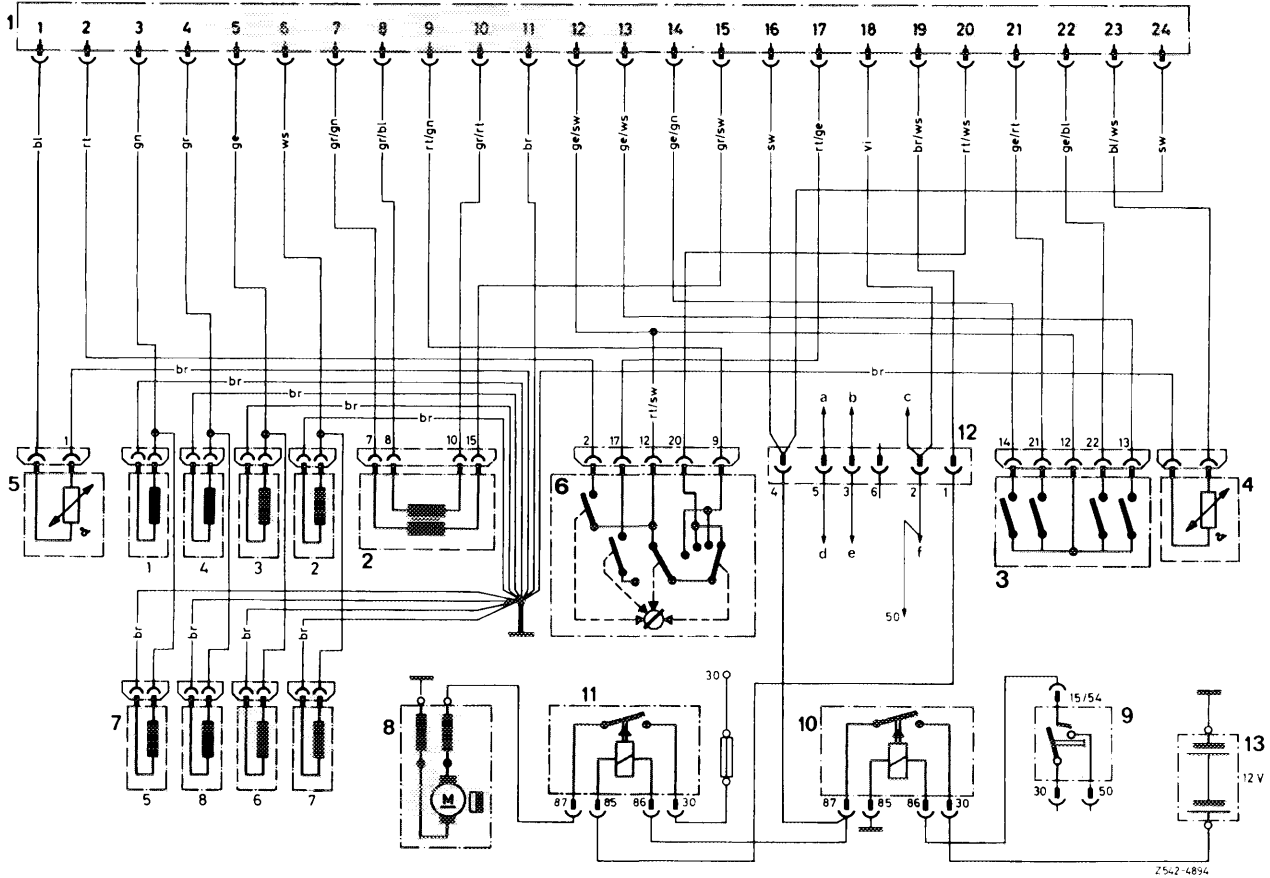

- 1 Multi-point connector (control unit)
- 2 Pressure sensor
- 3 Release contacts (ignition distributor)
- 4 Temperature sensor (coolant)
- 5 Temperature sensor (air)
- 6 Throttle valve switch  
Terminal 9 transition enrichment  
Terminal 20 transition enrichment  
Terminal 2 full-load contact  
Terminal 17 idle speed-contact  
Terminal 12 ground
- 7 Injection valves cylinder 1-8
- 8 Fuel pump
- 9 Ignition starting switch
- 10 Main relay (power supply control unit)
- 11 Pump relay
- 12 Intermediate plug (connection to vehicle harness)  
a Starting valve  
b Thermo-time switch terminal W  
c Thermo-time switch terminal G
- d Relay for starting valve terminal 87
- e Relay for starting valve terminal 85
- f Relay for starting valve terminal 86
- 13 Vehicle battery

## Relay layout

Code number	Relay function
1	Relay fuel pump
2	Relay starting valve
3	Main relay electronic injection

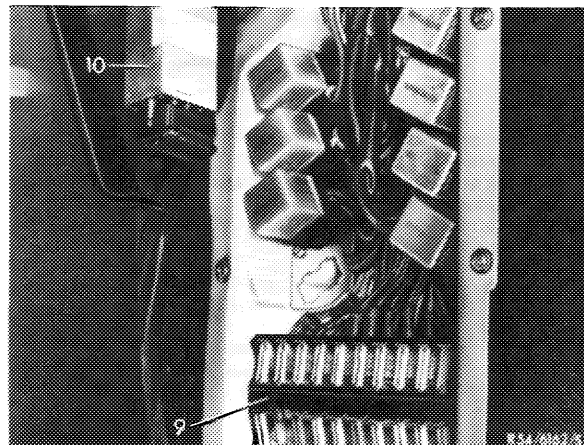

Model 107

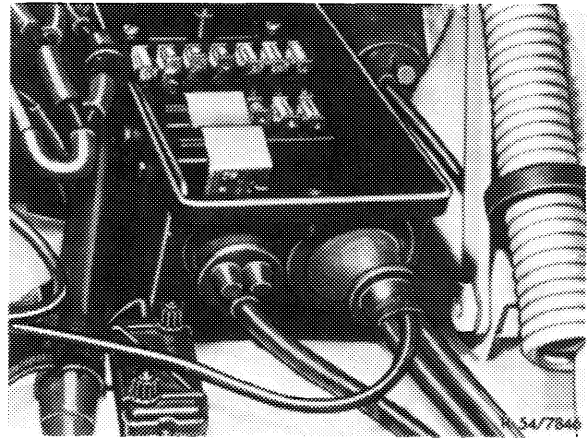

Model 116

Initial jobs for testing refer to 07.4–035.

**I. With control unit not connected**

Turn switch „A” on tester to position „measuring”, switch on ignition and complete all functions according to the following check list.

Switch „B” in position . . .	Actuate	Measure	Indication (nominal value volt-ohmmeter)	Nominal value not attained. Possible causes and remedy
<b>Voltage I</b>	Switch-on ignition and leave switched on throughout entire test sequence described below	Voltage supply for control unit	11 . . . 12.5 (11 . . . 12.5 V)	<p><b>Voltmeter indicates no voltage:</b>            Interruption: Plug connection from main relay (10) to control unit (line 16).            Main relay not attracting: Check voltage on terminal 86 of main relay, if there is no voltage, check fuse in fuse box.            Terminal 85 should be connected to ground. Measure voltage on terminal 87 of relay. If voltage is „0”, check terminal 30 of relay.</p> <p><b>Under load, voltage is below 11 V:</b>            Transfer-resistance on line 16 or on relay contact. Exchange main relay. Check cable from battery terminal plus to relay terminal 30.</p>
<b>Voltage II</b>				Similar to voltage I, but check line 24.
<b>Voltage starter</b>	Actuate starter for a moment	Voltage on terminal 50 of starter	9.0 . . . 12.0 (9.0 . . . 12.0 V)	<p><b>Voltmeter shows no voltage, but starter rotates:</b>            Line interruption from starter terminal 50 to control unit.            Check line to control unit terminal 18.</p> <p><b>Voltmeter indicates no voltage and starter is not rotating:</b>            Ignition starting switch defective, line interrupted.</p> <p><b>Voltage below 9.5 V:</b>            Battery discharged, voltage drop in line from ignition starter switch to terminal 50 of starter relay too high. Measure line with voltmeter for voltage drop.</p>
<b>Alignment <math>\infty</math> pressure sensor</b>	Adjust instrument by turning aligning knob to „ $\infty$ ”			If no full deflection is attained on instrument, battery voltage in vehicle is too low. Also refer to test step: Voltage I.
	Push button „ground”	Resistance between pressure sensor windings and ground (ground connection)	Resistance „ $\infty$ ” ( $\infty$ )	<p><b>Resistance „0”:</b>            Ground connection in supply line or on pressure sensor. Pull plug from pressure sensor, if indication is „<math>\infty</math>”, exchange pressure sensor; if indication remains unchanged at „0”, lines 7, 8, 10 or 15 may have a short circuit, replace cable harness.</p> <p><b>Resistance below „<math>\infty</math>”, but not „0”:</b>            Insulation damage, remedy see above.</p>

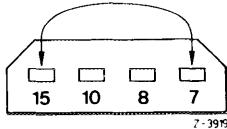
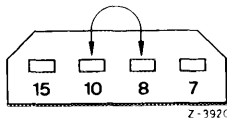
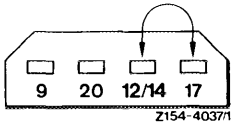
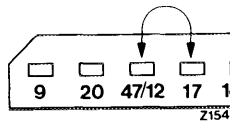
Switch „B” in position ...	Actuate	Measure	Indication (nominal value volt-ohmmeter)	Nominal value not attained. Possible causes and remedy
<b>Alignment ∞, pressure sensor</b>	Push „primary” button	Resistance of primary winding of pressure sensor	0.8 . . . 1.2 on ohm scale (approx. 90 ohms)	<p><b>Resistance essentially lower than nominal:</b> Insulation damage: Pull plug from pressure sensor, if indication then is „∞”, exchange pressure sensor.</p> <p><b>Resistance „0”:</b> Short circuit in winding. Pull plug from pressure sensor, if indication then is „∞”, exchange pressure sensor.</p> <p><b>Resistance considerably higher than nominal:</b> High transfer resistance. Check plug and lines for corrosion or interruption.</p> <p><b>Resistance „∞”:</b> Interruption. Bridge terminal 7 and 15 on plug. If indication is „0”, exchange pressure sensor. If indication is „∞”, check lines.</p>
				 <p>Top view on plug</p>
	Push „secondary” button	Resistance of secondary winding of pressure sensor	3 . . . 4 on ohm scale (approx. 350 ohms)	<p>Similar to „primary”. If resistance is „∞”, bridge terminals 8 and 10.</p> 
<b>ZV contact I ZV contact II ZV contact III ZV contact IV</b>	Rotate ignition distributor by brief actuation of starter	Function of release contact in ignition distributor	Alternately resistance „0” and „∞” (0/∞ ohms)	If the pointer of the instrument is not swinging back and forth while starting or stops in position ∞ or 0, check connections 12, 13, 14, 21 and 22 on contact slide-in. If connections and cable harness to control unit are in order, renew release contacts, adjustment is not possible.
<b>Throttle valve switch I then throttle valve switch II</b>	Step down slowly on accelerator pedal	Function of transfer enrichment	Pointer of instrument swings approx. 10 times between „0” and „∞” (alternately 0/∞ ohms)	<p>When the floored gas pedal is moving back, the pointer of the instrument should remain in position „∞”.</p> <p><b>Indication „0”:</b> Throttle valve switch defective, exchange.</p>
<b>Throttle valve switch III</b>	a) Throttle valve in idle position (closed)	Function of contact in throttle valve switch	a) 0 (0 ohm)	<b>a) Resistance „∞”:</b> Throttle valve switch wrongly set or interruption in supply line. Check adjustment. Pull-off plug, bridge terminals 12 and 17. If then still „∞”, exchange cable line, otherwise exchange throttle valve switch.
	b) Throttle valve slightly opened approx. 1° = 0.4 mm		b) ∞ (∞ ohm)	<b>b) Resistance „0”:</b> Throttle valve switch wrongly adjusted or short circuit in supply line. Pull-off plug, if indication is still „0”, exchange cable line, otherwise adjust or exchange throttle valve switch.
				 <p>Engine 116</p>  <p>Engine 117</p>

(ZV = ignition distributor)

Checking throttle valve switch — full-load contact (refer to section II, item Pressure switch).

Switch „B” in position . . .	Actuate	Measure	Indication (nominal value voltohmmeter)	Nominal value not attained. Possible causes and remedy.
<b>Temperature sensor I</b> (intake air)		Resistance of temperature sensor	2 . . . 5 at 20°C heavily dependent on temperature: 640 Ω at 0°C 400 Ω at 10°C 300 Ω at 20°C 210 Ω at 30°C 150 Ω at 40°C	Nominal value applies to 20°C. Resistance becomes lower at higher temperature. If measurements are not 0 or ∞, sensor is in order.  <b>Indication „∞”:</b> Interruption. Pull-off plug and bridge, if indication is „0”, exchange temperature sensor, otherwise cable line.  <b>Indication „0”:</b> Short circuit. Pull-off plug, if indication remains unchanged. Cable is defective. If indication then is „∞”, exchange temperature sensor.
<b>Temperature sensor II</b> (cooling water)		Resistance of temperature sensor	0.2 . . . 0.4 at 80°C heavily dependent on temperature: 5.9 kΩ at 0°C 2.5 kΩ at 20°C 1.2 kΩ at 40°C 600 Ω at 60°C 325 Ω at 80°C 190 Ω at 100°C	Refer to temperature sensor I. Nominal value applies to 80°C cooling water temperature.
<b>Valves</b> if required, balance instrument once again to „∞” (switch position „valves”)	Button 1 = valves cyl. 1 and 5 Button 2 = valves cyl. 3 and 6 Button 3 = valves cyl. 2 and 7 Button 4 = valves cyl. 4 and 8  <b>Attention!</b> Prior to actuating buttons always pull one valve plug on injection valve, so that only one valve is measured, e.g. cylinder 1 or 5, or 2 or 7.	Resistance of valve winding with supply line	2 . . . 3 (2.4 Ω at 20°C)	<b>Resistance „0”:</b> Short circuit in supply line or on valve. Pull plug from respective valve, if indication then is „∞”, exchange valve, otherwise exchange cable line.  <b>Resistance „∞”:</b> Interruption in supply line or in valve coil. Bridge contacts in valve plug, if indication then is „0”, valve is defective.  <b>Resistance above „3”:</b> Ground line of valves poorly connected to engine.

Switch „A” in position . . . (switch „B” has no influence)	Actuate	Measure	Indication (nominal value volt-ohmmeter)	Nominal value not attained. Possible causes and remedy.
<b>Valve test</b>	Push „pump” button	Connect pressure gauge. Pressure in fuel line	Nominal value 2.0 + 0.1 bar gauge pressure	<p><b>No pressure buildup</b> (pump not starting). Disconnect cable connections on pump, push „pump” button and measure voltage with voltmeter at cable ends. 12 volts readout indicates defective pump, exchange. If indication is „0”, check audibly whether pump relay attracts.</p> <p><b>If yes</b>, line interrupted from pump relay 87 to pump connections or from there to ground.</p> <p>Fuse in fuse box defective. If connecting line is in order, pump relay is defective.</p> <p><b>If no</b>, line interrupted from main relay terminal 87 to pump relay terminal 86 or from pump relay terminal 85 to control unit terminal 19 (ground for pump relay). If line is in order, check whether pump relay attracts when ground is connected directly to terminal 85, if yes, exchange control unit, if no, exchange pump relay.</p> <p><b>Pressure not corresponding to nominal value.</b> Pressure regulator maladjusted, adjust pressure regulator and exchange, if required.</p>
	Briefly push „pump” button	Leak test of fuel system (Pressure end)	Pressure may drop to 1.5 bar gauge pressure, then pressure should continue to drop only slightly	<p><b>Pressure drops immediately upon release of „pump” button below 1.5 bar gauge pressure</b></p> <ol style="list-style-type: none"> <li>1. Leaks in pressure line system, check visually whether hose connections are leaking.</li> <li>2. Leaking valve of delivery pump, of pressure regulator, of injection valves or of cold starting valve. To check which of the 4 components is leaking: Pinch pressure hose between fine filter and injection valves with delivery pump running by means of a clamp, switch off delivery pump. If the pressure is no longer dropping, valve in delivery pump is defective, exchange delivery pump. But if pressure still drops: Check pressure regulator. Pull return flow hose from pressure regulator immediately after stopping delivery pump. If fuel emerges, replace pressure regulator. If no fuel emerges and pressure is still dropping: Determine by means of spark plug patterns whether individual injection valves or cold-starting valve are leaking. Deviations among plug patterns point to leaking injection valves, while uniformly dark plug patterns point to a leaking starting valve. Check accurately upon removal of valves, connected to pressure system, with delivery pump engaged. Valve opening may become wet. But there should be no more than two drops per minute.</li> </ol>

Switch „A” in position . . . (switch „B” has no influence)	Actuate	Measure	Indication (nominal value volt-ohmmeter)	Nominal value not attained. Possible causes and remedy.
<b>Attention!</b> Perform the following test only if a fault is suspected on injection valve. <b>Valves removed.</b>	Pressure buildup: Push „pump” button. Push buttons 1 to 4 one after the other. When pushing buttons, pull-off respective plug of valve in valve group not tested at the moment.	Visual checkup. Valve spray test. Catch fuel.		Push „pump” button and check visually for leaks. Valve opening may become wet, but there should be no more than 2 drops per minute on one valve. If no leak is found, exchange pressure regulator.
<b>Starting valve</b> cooling water temperature above +35°C	a) Push „pump” button, actuate starter for one second.  b) Connect connection „W” of thermo-time switch to ground.	Function of thermo-time switch and starting valve	a) Pressure gauge should not visibly drop.  b) Starting valve injects, pressure gauge indication drops.	a) <b>Pressure drops steadily when starter is actuated.</b> Thermo-time switch defective, exchange.  b) <b>Pressure not dropping when starter is actuated</b> Check lines from starting valve to connection 87 of relay or to ground. If connecting lines are in order, check starting valve.  <b>Note:</b> Starting approx. September 1975, relays are no longer installed.
Cooling water temperature below +35°C	Push „pump” button, actuate starter for one second (thermo-time switch again normally connected)		Pressure should drop.	If pressure is not dropping, renew thermo-time switch or check starting valve as described under b). Interturn resistance 4.2 ohms at 20°C.

Switch off ignition, remove pressure gauge.

## II. With control unit connected

Connect multiple plug of tester to control unit. The position of switch „B” on tester has no influence on test sequence.

Switch „A” in position	Actuate	Measure	Indication (nominal value volt-ohmmeter)	Nominal value is not attained. Possible causes and remedy.
ZV contact I ZV contact II ZV contact III ZV contact IV	Rotate ignition distributor by operating starter for a short moment	Function of release contacts in ignition distributor	Alternately resistance „10” and „∞” (0/∞ ohm)	If the needle of the instrument is not swinging while starting or remains in position ∞ or 0, check connections 12, 13, 14, 21 and 22 on contact slide-in. If connections and cable harness for control unit are in order, renew release contacts. Adjustment is not possible.
Pressure switch engine 117 only	Switch on ignition step down on accelerator pedal (full throttle)	Function of full throttle contact in throttle valve switch	2-5 on volt scale. Indication should come 5° before completely opened throttle valve.	Throttle valve switch defective, exchange.



## B. With volt-ohmmeter

### Conventional tools

Ohmmeter 0–10 000 ohm, voltmeter 0–16 volt

### Connection diagram for control unit

The following circuit diagram shows the individual components of the electronically controlled gasoline injection system and its connection to control unit.

### Engine 116

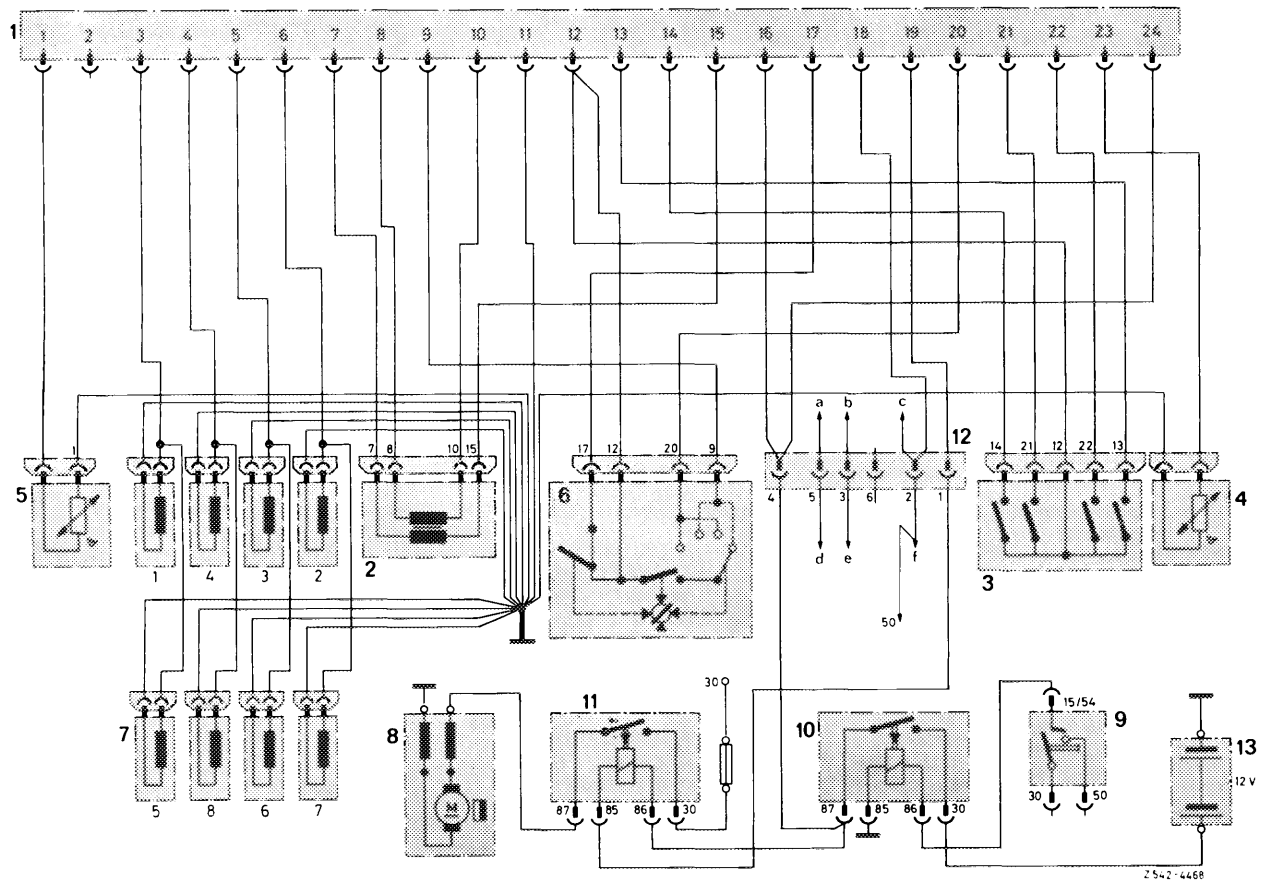

- 1 Multi-point connector, control unit
- 2 Pressure sensor
- 3 Release contact in ignition distributor
- 4 Temperature sensor coolant
- 5 Temperature sensor air
- 6 Throttle valve switch
- Terminal 9 transmission enrichment
- Terminal 20 transition enrichment
- Terminal 12 ground
- Terminal 17 idle speed contact

- 7 Injection valves
- 8 Fuel pump
- 9 Ignition starting switch
- 10 Main relay electronics
- 11 Pump relay

- 12 Plug connection to vehicle harness
  - a To cold starting valve
  - b To thermo-time switch terminal W
  - c To thermo-time switch terminal G
  - d To cold starting relay terminal 87
  - e To cold starting relay terminal 85
  - f To cold starting relay terminal 86
- 13 Vehicle battery

# Engine 117

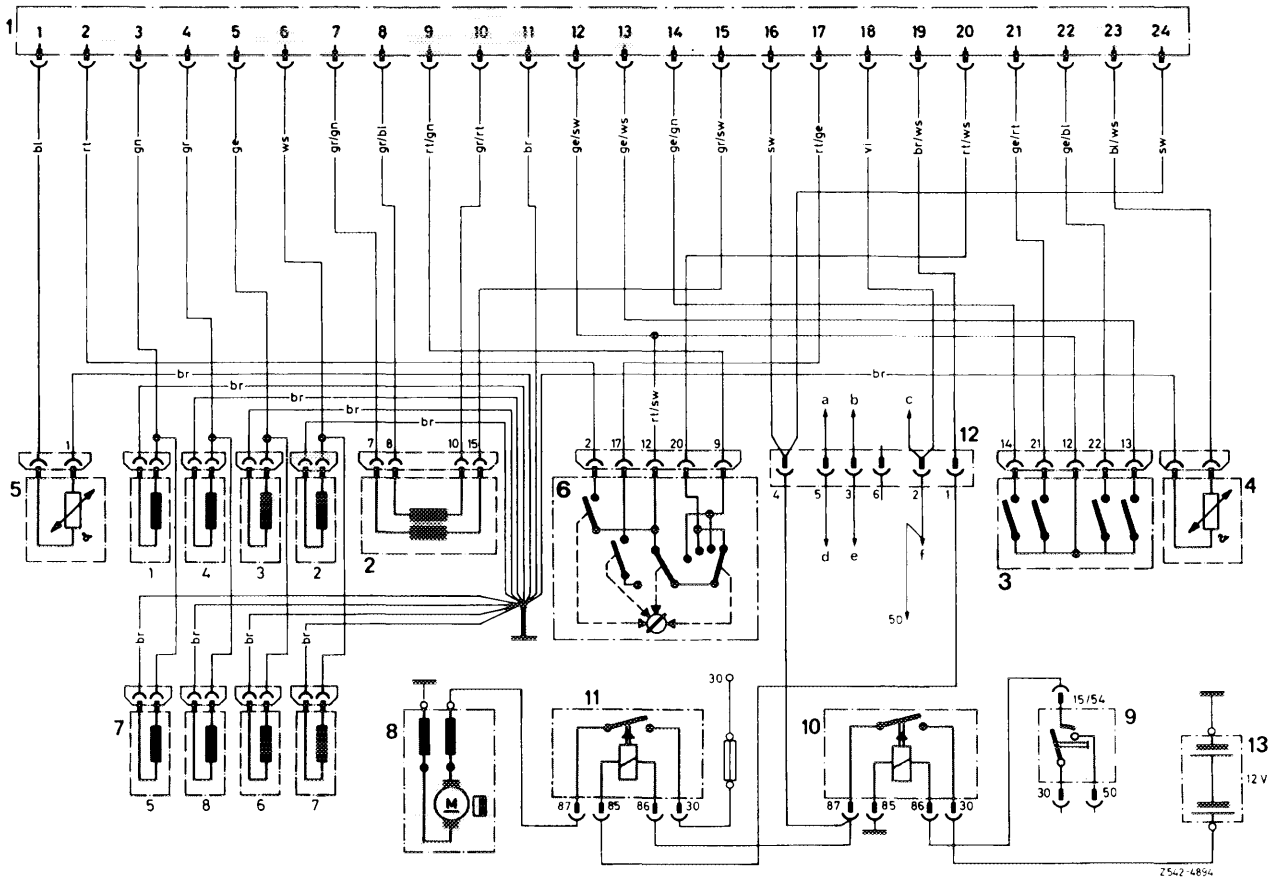

- 1 Multi-point connector (control unit)
- 2 Pressure sensor
- 3 Release contacts (ignition distributor)
- 4 Temperature sensor (coolant)
- 5 Temperature sensor (air)
- 6 Throttle valve switch
- 7 Injection valves cylinders 1–8
- 8 Fuel pump
- 9 Ignition starting switch
- 10 Main relay (power supply control unit)
- 11 Pump relay
- 12 Intermediate plug (connection to vehicle harness)
- a Starting valve
- b Thermo-time switch terminal W
- c Thermo-time switch terminal G
- d Relay for starting valve terminal 87
- e Relay for starting valve terminal 85
- f Relay for starting valve terminal 86
- 13 Vehicle battery

## Relay layout

Code number	Relay function
1	Relay fuel pump
2	Relay starting valve
3	Main relay electronic injection

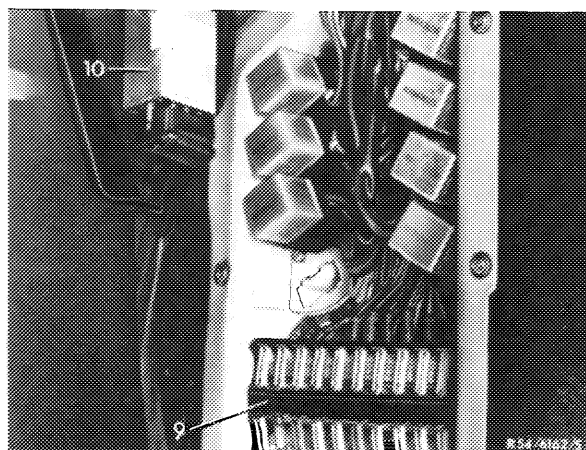

Model 107

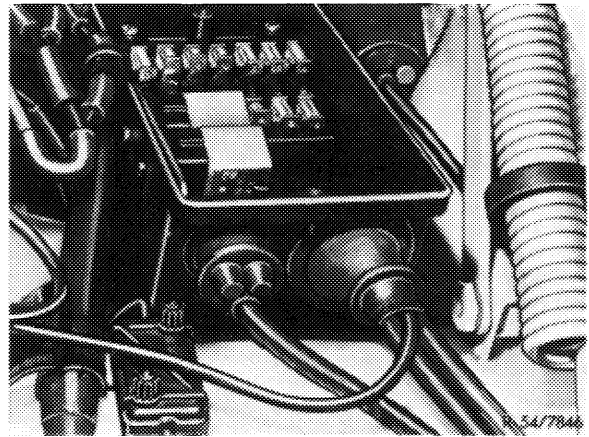

Model 116

Initial jobs for testing (refer to 07.4--035)

## Testing

### Voltage at multi-point connector of control unit

Actuate:	Switch-on ignition and leave switched on throughout entire test sequence described below.
Measure:	Voltage supply for control unit.
Connection electronic control unit multi-point contactor:	Voltage I terminal 11 and terminal 16 Voltage II terminal 11 and terminal 24
Nominal value:	11 V
Nominal value not attained.	
Possible causes and remedy:	<p><b>Voltmeter indicates no voltage:</b></p> <p>Interruption: Plug connection from main relay (10) to control unit (line 16).</p> <p>Main relay not attracting: Check voltage on terminal 86 of main relay, if there is no voltage, check fuse in fuse box. Terminal 85 should be connected to ground.</p> <p>Measure voltage on terminal 87 of relay. If connection is „0“, check terminal 30 of relay.</p> <p><b>Under load, voltage is below 11 V:</b></p> <p>Transfer resistance on line 16 or on relay contact. Exchange main relay.</p> <p>Check cable from battery terminal plus to relay terminal 30.</p>

---

### Voltage starter terminal 50

---

Actuate:	Starter
Measure:	Voltage on terminal 50
Connection electronic control unit multi-point contactor:	Terminal 11 and terminal 18
Nominal value:	9.5 V
Nominal value not attained.	
Possible causes and remedy:	<p><b>Voltmeter shows no voltage, but starter rotates:</b> Line interruption from starter terminal 50 to control unit terminal 18.</p> <p><b>Voltmeter indicates no voltage and starter is not rotating:</b> Ignition starting switch defective, line interrupted terminal 50.</p> <p><b>Voltage below 9.5 V:</b> Battery discharged, voltage drop in line from ignition starter switch to terminal 50 of starter relay too high. Measure line with voltmeter for voltage drop.</p>

---

### Pressure sensor

---

Measure:	Pressure sensor connected to ground.
Connection electronic control unit multi-point contactor:	Terminal 7 and terminal 11 Terminal 8 and terminal 11
Nominal value:	Resistance „∞“
Nominal value not attained.	
Possible causes and remedy:	<p><b>Resistance „0“:</b> Ground connection in supply line or on pressure sensor. Pull plug from pressure sensor, if indication is „∞“, exchange pressure sensor; if indication remains unchanged at „0“, lines 7 and 8 may have a short circuit, replace cable harness.</p> <p>Resistance below „∞“, but not „0“: Insulation damage, remedy see above.</p>

---

---

Measure: Primary winding of pressure sensor.

Connection electronic control unit multi-point contactor: Terminal 7 and terminal 15

Nominal value: approx. 90 ohms

Nominal value not attained.

Possible causes and remedy: **Resistance essentially lower than nominal:**  
Insulation damage: Pull plug from pressure sensor if indication then is „∞“, exchange pressure sensor.  
**Resistance „0“:**  
Short circuit in winding. Pull plug from pressure sensor, if indication is then „∞“, exchange pressure sensor. **Resistance considerably higher than nominal:** High transfer resistance. Check plug and lines for corrosion or interruption.

**Resistance „∞“:**  
Interruption. Bridge terminal 7 and 15 on plug. If indication is „0“, exchange pressure sensor. If indication is „∞“, check lines.

Top view on plug

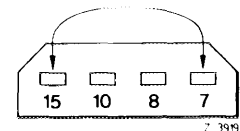

---

Measure: Secondary winding of pressure sensor.

Connection electronic control unit multi-point contactor: Terminal 8 and terminal 10

Nominal value: approx. 350 ohms

Nominal value not attained.

Possible causes and remedy: Similar to „primary“. If resistance is „∞“, bridge terminals 8 and 10.

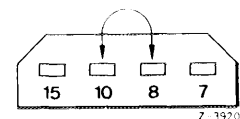

---

### Function of release contacts in ignition distributor

---

Actuate: Rotate ignition distributor by brief actuation of starter.

Measure: Function of release contact in ignition distributor.

Connection electronic control unit multi-point contactor: ZV contact I terminal 12 and 21  
ZV contact II terminal 12 and 22  
ZV contact III terminal 12 and 13  
ZV contact IV terminal 12 and 14

Nominal value: Alternately resistance „0“ and „∞“

Nominal value not attained.

Possible causes and remedy: If the pointer of the instrument is not swinging back and forth while starting or stops in position  $\infty$  or 0, check connections 12, 21, 22, 13 and 14 on contact slide-in. If connections to control unit are in order, renew release contact, adjustment is not possible.

---

### Throttle valve switch conductor path I and II

---

Actuate: Step down slowly on accelerator pedal.

Measure: Function of transfer enrichment.

Connection electronic control unit multi-point contactor: I terminal 9 and terminal 12  
II terminal 20 and terminal 12

Nominal value: Pointer of instrument swings approx. 10 times between „0” and „ $\infty$ ”

Nominal value not attained.

Possible causes and remedy: When the floored pedal is moving back, the pointer of the instrument should remain in position „ $\infty$ ”.

**Indication „0”:**

Throttle valve switch defective, exchange.

---

### Throttle valve switch III

---

Actuate: 1. Throttle valve switch at idle (closed).  
2. Throttle valve switch slightly opened (approx.  $1^\circ = 0.4 \text{ mm}$ ).

Measure: Function of contacts in throttle valve switch.

Connection electronic control unit multi-point contactor: Terminal 12 and terminal 17

Nominal value: 1. „0”  
2. „ $\infty$ ”

Nominal value not attained.

Possible causes and remedy:

**a) Resistance „ $\infty$ ”:**

Throttle valve switch wrongly set or interruption in supply line. Check adjustment. Pull-off plug, bridge terminals 12 and 17.

If then still „ $\infty$ ”, exchange cable line, otherwise exchange throttle valve switch.

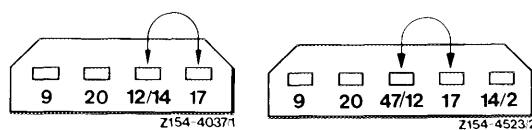

Engine 116

Engine 117

**b) Resistance „0”:**

Throttle valve switch wrongly adjusted or short circuit in supply line. Pull-off plug, if indication is still „0”, exchange cable line, otherwise adjust or exchange throttle valve switch.

---

### Full-load contact in throttle valve switch (engine 117 only)

---

Check: Full-throttle checkup of accelerator pedal.

Actuate: Step down fully on accelerator pedal.

Measure: Full-load contact of throttle valve switch.

Connection electronic control unit multi-point contactor: Terminal 12 and terminal 2

Nominal value: „0”

Nominal value not attained.

Possible causes and remedy: **Resistance „∞”:**  
Throttle valve switch wrongly adjusted or interruption in supply line. Check adjustment. Pull plug, bridge terminal 12 and 2.  
If then still „∞”, exchange cable line, otherwise exchange throttle valve switch.

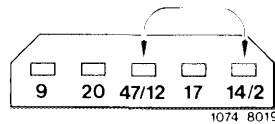

---

### Temperature sensor I (air)

---

Measure: Resistance of temperature sensor.

Connection electronic control unit multi-point contactor: Terminal 1 and terminal 11

Nominal value: Heavily dependent on temperature:  
640 Ω at 0°C  
400 Ω at 10°C  
300 Ω at 20°C  
210 Ω at 30°C  
150 Ω at 40°C

Nominal value not attained.

Possible causes and remedy: Resistance decreasing at increasing temperature. Sensor is in order, unless 0 or ∞ is measured.

**Indication „∞”:**

Interruption. Pull-off plug and bridge, if indication is „0”, exchange temperature sensor, otherwise cable line.

**Indication „0”:**

Short circuit. Pull-off plug, if indication remains unchanged, cable is defective. If indication is then „∞”, exchange temperature sensor.

---

---

### Temperature sensor II (coolant)

---

Measure: Resistance of temperature sensor

Connection electronic control unit multi-point contactor: Terminal 11 and terminal 23

Nominal value: Heavily dependent on temperature:

5.9 k $\Omega$  at 0°C

2.5 k $\Omega$  at 20°C

1.2 k $\Omega$  at 40°C

600  $\Omega$  at 60°C

325  $\Omega$  at 80°C

190  $\Omega$  at 100°C

Nominal value not attained.

Possible causes and remedy: Refer to temperature sensor I

---

### Injection valves (1- 8)

---

Actuate: During measurements always pull-off one valve plug on electric injection valve, so that only one valve is measured at a time, e.g. cylinder 1 or 5, or 3 or 6.

Measure: Resistance of valve winding with supply line.

Connection electronic control unit multi-point contactor:

1. Terminal 3 and terminal 11 injection valve 1 and 5
2. Terminal 5 and terminal 11 injection valve 3 and 6
3. Terminal 4 and terminal 11 injection valve 4 and 8
4. Terminal 6 and terminal 11 injection valve 2 and 7

Nominal value: 2.5 – 3 ohms each injection valve

Nominal value not attained.

Possible causes and remedy: **Resistance „0“:**  
Short circuit in supply line or on valve. Pull plug from respective valve, if indication is then „ $\infty$ “, exchange valve, otherwise exchange cable line.

**Resistance „ $\infty$ “:**  
Interruption in supply line or in valve coil. Bridge contacts in valve plug, if indication is then „ $\infty$ “, cable line is defective. If indication is „0“, valve is defective.

**Resistance at terminal 11:**  
Ground line of valves poorly connected to engine.

---



---

### Electric fuel pump and electric lines

---

Actuate:	Switch-on ignition.
Measure:	Electric fuel pump and electric lines.
Connection electronic control unit multi-point contactor:	Connect terminal 11 and terminal 19.
Nominal value:	11.5 V on cable connections fuel pump.
Nominal value not attained.	
Possible causes and remedy:	<p>Fuel pump not starting.</p> <p>Disconnect cable connections on pump, measure voltage with voltmeter at cable ends. 12 volts readout indicates defective pump, exchange. If indication is „0“, check audibly whether pump relay attracts.</p> <p><b>If yes,</b></p> <p>line interrupted from pump relay 87 to pump connections or from there to ground.</p> <p>Fuse in fuse box defective.</p> <p>If connecting lines are in order, pump relay is defective.</p> <p><b>If no,</b></p> <p>line interrupted from main relay terminal 87 to pump relay terminal 86 or from pump relay terminal 85 to control unit terminal 19 (ground for pump relay). If lines are in order, check whether pump relay attracts when ground is connected directly to terminal 85, if yes, exchange control unit. If no, exchange pump relay.</p>

---

### Checking fuel pressure and leaks in ring line

---

Refer to 07.4–120

---

### Starting device

---

Actuate:	Actuate starter.
Measure:	Function of thermo-time switch (+35°C)
Connection:	To coupling plug of cold starting valve.
Nominal value:	10 volts below +35°C coolant temperature.
Nominal value not attained.	
Possible causes and remedy:	<p>If there is no voltage, check fuse, also check line from cold starting valve to relay and to thermo-time switch.</p> <p>If fuse and line are in order:</p> <p>Connect terminal „W“ of thermo-time switch to ground.</p> <p>If line is now carrying voltage, the thermo-time switch is defective, exchange thermo-time switch.</p> <p>If there is no voltage, replace relay.</p>

**Testing thermo-time switch with ohmmeter:**

**Test values above +35°C**

- Connection W – ground = approx. 100 ohms
- Connection G – ground = approx. 60 ohms
- Connection G – W = approx. 40 ohms

**Test values below +35°C**

- Connection G – ground = approx. 20 ohms
- Connection W – ground = approx. 0 ohms (contacts in switch closed)

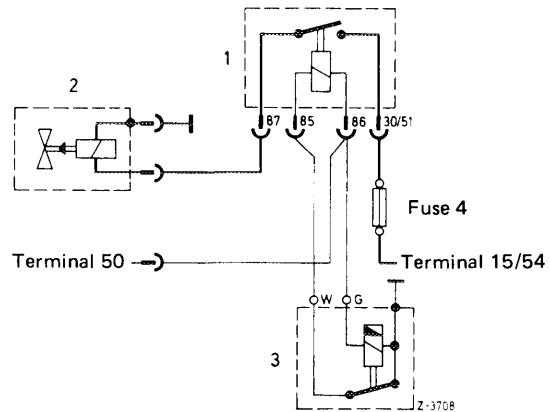

Wiring diagram of starting device with relay

- 1 Relay
- 2 Starting valve
- 3 Thermo-time switch

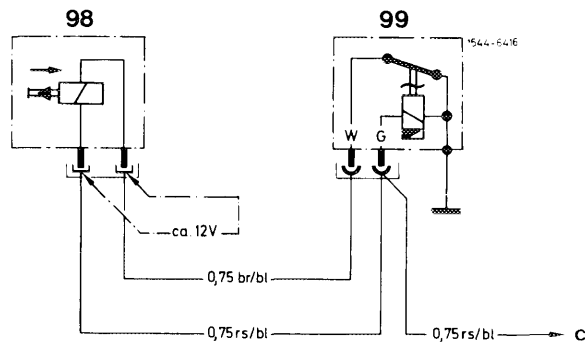

Wiring diagram of starting device without relay starting September 1975

- 98 Cold starting valve
- 99 Thermo-time switch
- c To terminal 50

**Offset of release contacts in ignition distributor**

Actuate:	Connect control unit, run engine at approx. 2000/min.
Measure:	Offset of release contacts in ignition distributor.
Connection electronic control unit multi-point contactor:	<ol style="list-style-type: none"> <li>1. Terminal 12 and terminal 21</li> <li>2. Terminal 12 and terminal 22</li> <li>3. Terminal 12 and terminal 13</li> <li>4. Terminal 12 and terminal 14</li> </ol>
Nominal value:	Pointer of voltmeter swings to a mean value. When changing connections, the deviation may amount to max 0.4 V of mean value.
Nominal value not attained.	
Possible causes and remedy:	If deviations are higher, renew release contact slide-in in ignition distributor.

**C. With Bosch tester KD-JED 7500**

The test jobs are shown in test list of unit.